

# Panasonic®

## Operating Instructions

### Multi-format Live Switcher

Model No. **AV-HS300G**

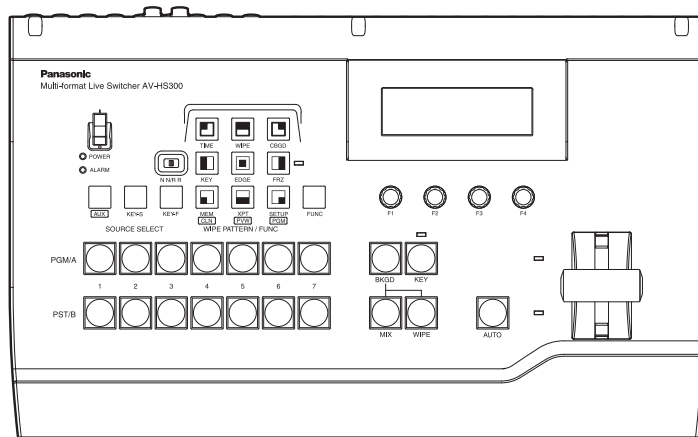

Before operating this product, please read the instructions carefully and save this manual for future use.

# Safety precautions



## CAUTION

**RISK OF ELECTRIC SHOCK  
DO NOT OPEN**



CAUTION: TO REDUCE THE RISK OF ELECTRIC SHOCK,  
DO NOT REMOVE COVER (OR BACK).  
NO USER SERVICEABLE PARTS INSIDE.  
REFER TO SERVICING TO QUALIFIED SERVICE PERSONNEL.



The lightning flash with arrowhead symbol, within an equilateral triangle, is intended to alert the user to the presence of uninsulated "dangerous voltage" within the product's enclosure that may be of sufficient magnitude to constitute a risk of electric shock to persons.



The exclamation point within an equilateral triangle is intended to alert the user to the presence of important operating and maintenance (service) instructions in the literature accompanying the appliance.

For CANADA

**This class A digital apparatus complies with Canadian ICES-003.**

**Cet appareil numérique de la classe A est conforme à la norme NMB-003 du Canada.**

## WARNING:

- TO REDUCE THE RISK OF FIRE OR ELECTRIC SHOCK, DO NOT EXPOSE THIS APPARATUS TO RAIN OR MOISTURE.
- THE APPARATUS SHALL NOT BE EXPOSED TO DRIPPING OR SPLASHING AND THAT NO OBJECTS FILLED WITH LIQUIDS, SUCH AS VASES, SHALL BE PLACED ON THE APPARATUS.

## WARNING:

TO PREVENT INJURY, THIS APPARATUS MUST BE SECURELY ATTACHED TO THE FLOOR/WALL IN ACCORDANCE WITH THE INSTALLATION INSTRUCTIONS.

## CAUTION:

TO REDUCE THE RISK OF FIRE OR SHOCK HAZARD AND ANNOYING INTERFERENCE, USE THE RECOMMENDED ACCESSORIES ONLY.

## FCC Note:

This equipment has been tested and found to comply with the limits for a class A digital device, pursuant to Part 15 of the FCC Rules. These limits are designed to provide reasonable protection against harmful interference when the equipment is operated in a commercial environment. This equipment generates, uses, and can radiate radio frequency energy, and if not installed and used in accordance with the instruction manual, may cause harmful interference to radio communications. Operation of this equipment in a residential area is likely to cause harmful interference in which case the user will be required to correct the interference at his own expense.

## Warning:

To assure continued FCC emission limit compliance, the user must use only shielded interface cables when connecting to external units. Also, any unauthorized changes or modifications to this equipment could void the user's authority to operate it.

## CAUTION:

In order to maintain adequate ventilation, do not install or place this unit in a bookcase, built-in cabinet or any other confined space. To prevent risk of electric shock or fire hazard due to overheating, ensure that curtains and any other materials do not obstruct the ventilation.

## Note:

The rating plate (serial number plate) is on the bottom of the unit.

The socket outlet shall be installed near the equipment and easily accessible or the mains plug or an appliance coupler shall remain readily operable.

A warning that an apparatus with CLASS I construction shall be connected to a MAINS socket outlet with a protective earthing connection.

# Safety precautions

## IMPORTANT SAFETY INSTRUCTIONS

Read these operating instructions carefully before using the unit. Follow the safety instructions on the unit and the applicable safety instructions listed below. Keep these operating instructions handy for future reference.

- 1) Read these instructions.
- 2) Keep these instructions.
- 3) Heed all warnings.
- 4) Follow all instructions.
- 5) Do not use this apparatus near water.
- 6) Clean only with dry cloth.
- 7) Do not block any ventilation openings. Install in accordance with the manufacturer's instructions.
- 8) Do not install near any heat sources such as radiators, heat registers, stoves, or other apparatus (including amplifiers) that produce heat.
- 9) Do not defeat the safety purpose of the polarized or grounding-type plug. A polarized plug has two blades with one wider than the other. A grounding-type plug has two blades and a third grounding prong. The wide blade or the third prong are provided for your safety. If the provided plug does not fit into your outlet, consult an electrician for replacement of the obsolete outlet.
- 10) Protect the power cord from being walked on or pinched particularly at plugs, convenience receptacles, and the point where they exit from the apparatus.
- 11) Only use attachments/accessories specified by the manufacturer.
- 12) Use only with the cart, stand, tripod, bracket, or table specified by the manufacturer, or sold with the apparatus. When a cart is used, use caution when moving the cart/apparatus combination to avoid injury from tip-over. 
- 13) Unplug this apparatus during lightning storms or when unused for long periods of time.
- 14) Refer all servicing to qualified service personnel. Servicing is required when the apparatus has been damaged in any way, such as power-supply cord or plug is damaged, liquid has been spilled or objects have fallen into the apparatus, the apparatus has been exposed to rain or moisture, does not operate normally, or has been dropped.

# Safety precautions

---

## **Information on Disposal for Users of Waste Electrical & Electronic Equipment (private households)**



This symbol on the products and/or accompanying documents means that used electrical and electronic products should not be mixed with general household waste. For proper treatment, recovery and recycling, please take these products to designated collection points, where they will be accepted on a free of charge basis. Alternatively, in some countries you may be able to return your products to your local retailer upon the purchase of an equivalent new product.

Disposing of this product correctly will help to save valuable resources and prevent any potential negative effects on human health and the environment which could otherwise arise from inappropriate waste handling. Please contact your local authority for further details of your nearest designated collection point. Penalties may be applicable for incorrect disposal of this waste, in accordance with national legislation.

### **For business users in the European Union**

If you wish to discard electrical and electronic equipment, please contact your dealer or supplier for further information.

### **Information on Disposal in other Countries outside the European Union**

This symbol is only valid in the European Union.

If you wish to discard this product, please contact your local authorities or dealer and ask for the correct method of disposal.

# Contents

---

|  |           |  |           |
|--|-----------|--|-----------|
| <b>Description .....</b>                                 | <b>6</b>  | <b>3. Setup .....</b>                                      | <b>28</b> |
| <b>Features .....</b>                                    | <b>6</b>  | 3-1 Setting the input signals .....                        | 28        |
| <b>Precautions for use .....</b>                         | <b>7</b>  | 3-1-1 Setting the input signals (IN 1 to 5) .....          | 28        |
| <b>1. Functions in each area .....</b>                   | <b>8</b>  | 3-1-2 Setting the input signal frame<br>synchronizer ..... | 28        |
| 1-1 Control panel .....                                  | 8         | 3-1-3 Setting the DVI input signals (IN6) .....            | 29        |
| 1-2 Crosspoint area .....                                | 9         | 3-2 Setting the output signals .....                       | 31        |
| 1-3 Wipe area .....                                      | 10        | 3-2-1 Types of output signals .....                        | 31        |
| 1-4 Transition area .....                                | 11        | 3-2-2 Selecting the AUX signals .....                      | 31        |
| 1-5 LCD menu area .....                                  | 12        | 3-3 Selecting the video format .....                       | 32        |
| 1-6 Rear panel connections area .....                    | 13        | 3-4 Setting the crosspoints .....                          | 33        |
| <b>2. Basic operations .....</b>                         | <b>14</b> | 3-4-1 Assigning signals to the crosspoints .....           | 33        |
| 2-1 Transitions .....                                    | 14        | 3-4-2 Setting the crosspoint switching .....               | 34        |
| 2-1-1 Selecting the bus .....                            | 14        | 3-5 Setting the sync signals .....                         | 35        |
| 2-1-2 Selecting the bus mode .....                       | 14        | 3-6 Adjusting the output signal phase .....                | 36        |
| 2-1-3 Selecting the transition mode .....                | 15        | 3-7 Network settings .....                                 | 38        |
| 2-1-4 Manual transition<br>(using the fader lever) ..... | 15        | 3-8 Other settings .....                                   | 40        |
| 2-1-5 Auto transition .....                              | 15        | 3-8-1 LCD backlight .....                                  | 40        |
| 2-2 Wipe .....   | 16        | 3-8-2 Setting the ancillary data .....                     | 40        |
| 2-2-1 Selecting the wipe pattern .....                   | 16        | 3-8-3 BB signal setup level .....                          | 40        |
| 2-2-2 Selecting the wipe direction .....                 | 16        | 3-9 Status displays .....                                  | 41        |
| 2-2-3 Wipe decorations<br>(border, soft effect) .....    | 16        | 3-10 Initialization .....                                  | 41        |
| 2-3 Key .....  | 18        | <b>4. Setting menu table .....</b>                         | <b>42</b> |
| 2-3-1 Selecting the key source .....                     | 18        | <b>5. Image transmission functions .....</b>               | <b>47</b> |
| 2-3-2 Setting the key .....                              | 19        | <b>6. External interfaces .....</b>                        | <b>51</b> |
| 2-3-3 Key adjustments .....                              | 19        | 6-1 RS-422 connector .....                                 | 51        |
| 2-3-4 Selecting key fill .....                           | 20        | 6-2 GPI connector .....                                    | 51        |
| 2-3-5 Key decorations .....                              | 21        | 6-3 Tally connector .....                                  | 52        |
| 2-4 Color background .....                               | 23        | <b>7. Connections .....</b>                                | <b>53</b> |
| 2-5 Freezing the input signals .....                     | 24        | <b>8. Appearance .....</b>                                 | <b>55</b> |
| 2-6 Frame memory .....                                   | 25        | <b>Specifications and<br/>standard accessories .....</b>   | <b>56</b> |
| 2-7 Preset memory .....                                  | 26        | <b>Appendix (glossary) .....</b>                           | <b>58</b> |

# Description

---

This unit is a 1ME digital video switcher which supports multiple HD and SD formats. While featuring compact dimensions, it can optionally support HD analog component inputs (×5) in addition to the five SDI inputs and one DVI-I input. Since a frame synchronizer is incorporated for each of the inputs, asynchronous video signals can be switched without “shocking” or “freezing”. Furthermore, the images created by a PC can be captured via Ethernet.

# Features

---

- **Six inputs, three outputs supported despite its compact size**

The standard configuration consists of six inputs (five SDI inputs and one DVI-I input) and three outputs of PGM, PVW and AUX (SDI, HD analog component). Optionally, the unit is also capable of supporting HD analog component inputs (×5).

The SDI inputs support active through outputs. Key inputs can be selected from the six video inputs for use.
- **Multiple formats supported**

HD formats (1080/59.94i, 1080/50i, 720/59.94p and 720/50p), SD formats (480/59.94i and 576/50i) and DVI-I (input only) are supported as the signal formats.
- **Frame synchronizer system as well as external sync system is supported**

The unit contains a high-performance 10-bit frame synchronizer to enable asynchronous images to be input. By using the BB (Black Burst) signal output, a system can be configured using the switcher’s sync signals as a reference.

Gen-lock is also possible with external sync signals (BB or Tri-level Sync).
- **Built-in effects and key combination functions**

The unit provides nine different wipe patterns to add borders or soft effects.

Key combination supports self keys and linear keys, and key invert is also possible.
- **Ethernet and control interfaces supported**

The unit can capture images created on a PC into its frame memory over Ethernet (100 Mbps or 10 Mbps) and use them as background images or key input signals.

External control using RS-422 or GPI signals is also supported. In addition, the unit comes with six tally outputs.
- **External power supply system**

The unit is powered by an external DC 12 V power supply so it can be used not only indoors but in the field as well. (However, the unit is not constructed to be rain-proof or drip-proof so keep it away from rain or moisture.)
- **Easy operability**

The simple panel layout which enables the functions to be operated directly enables speedy live transmissions. Preset-like operations can be performed using a menu-driven format.

# ***Precautions for use***

---

- **Handle carefully.**

Do not drop the product, or subject it to strong shock or vibration.

Do not carry or move the product by the fader lever. This is important to prevent trouble.

- **Use the product in an ambient temperature of 32 °F to 104 °F (0 °C to 40 °C).**

Avoid using the product at a cold place below 32 °F (0 °C) or at a hot place above 104 °F (40 °C) because extremely low or high temperature will adversely affect the parts inside.

- **Power off before connecting or disconnecting cables.**

Before plugging or unplugging the cables, be sure to switch power off.

- **Avoid humidity and dust.**

Avoid using the product at a humid, dusty place because much humidity and dust will cause damage to the parts inside.

- **Maintenance**

Wipe the product using a dry cloth. To remove stubborn dirt, dip a cloth into a diluted solution of kitchen detergent, wring it out well, and wipe the product gently. Then, after wiping the product with a moist cloth, wipe it again with a dry cloth.

### **Caution**

- Avoid using benzene, paint thinners and other volatile fluids.
- If a chemical cleaning cloth is to be used, carefully read through the precautions for its use.

# 1. Functions in each area

## 1-1. Control panel

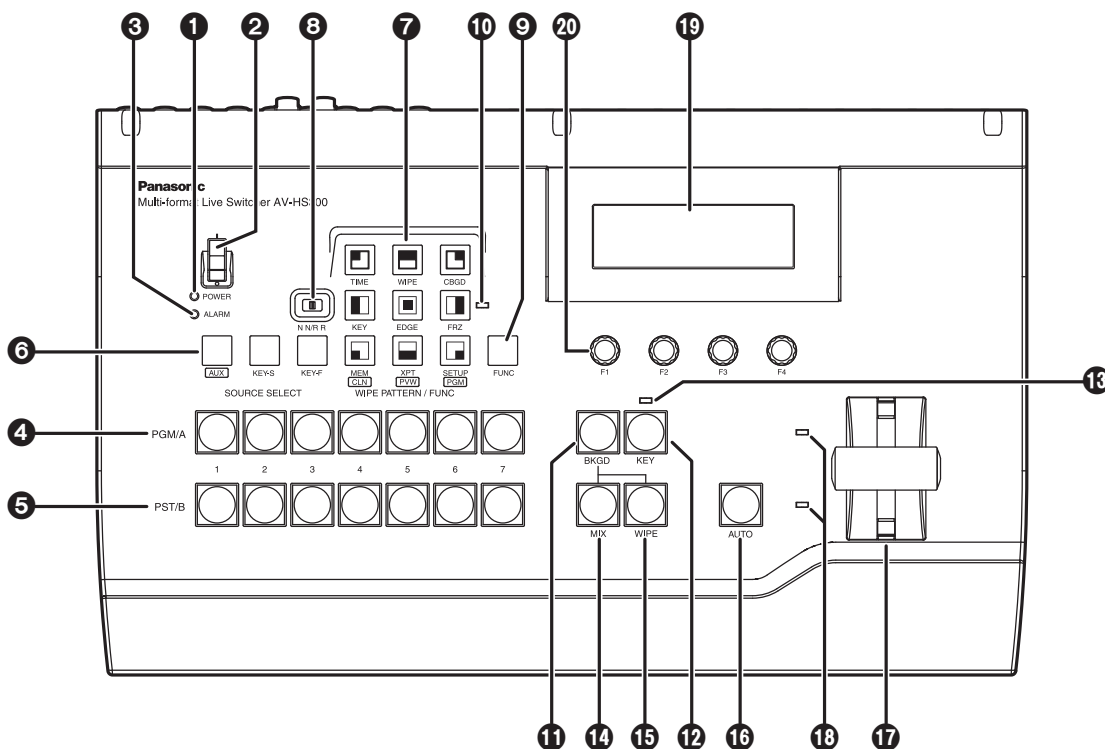

### 1 Power indicator [POWER]

This lights when the power switch (2) is set to ON while power is supplied to the DC power socket. It goes off when the power switch (2) is set to OFF.

### 2 Power switch

When this switch is set to "I" while power is supplied to the DC power socket, the unit's power is turned on, and the power indicator (1) lights. When it is set to "O", the unit's power is turned off, and the power indicator (1) goes off.

### 3 Alarm indicator [ALARM]

This lights when the fan has stopped running or when something is wrong with the DC power (such as a drop in voltage). When the alarm goes off you can check the type of problem with the ALM item under the SETUP/STATS (15/15) menu. An alarm message will also appear on the LCD.

| ALARM TYPE                | SETUP/STATS (15/15) ALM | ALARM MESSAGE                |
|---------------------------|-------------------------|------------------------------|
| Fan alarm                 | FAN                     | ALARM! FAN STOP              |
| Power alarm               | POWER                   | ALARM! POWER DOWN            |
| Power alarm and fan alarm | F, P                    | ALARM! POWER DOWN & FAN STOP |

If the fan alarm goes off, stop using the unit immediately and be sure to contact your dealer. If the power alarm goes off, stop using the unit immediately and check the power. Continuing to use the unit even after the alarm goes off could damage it.

If the temperature inside the unit increases due to the fan stopping or some other reason, the safety function will activate and the power of the unit will be turned off.



# 1. Functions in each area

---

## 1-2. Crosspoint area

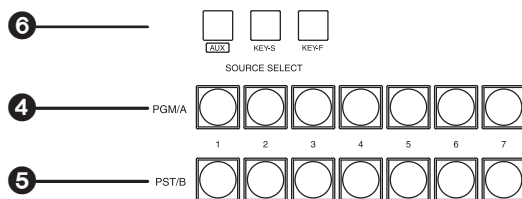

### ④ PGM/A bus crosspoint switches [PGM/A 1 to 7]

These are used to select the PGM/A bus video signals. In the case of the flip-flop system, the main line video (PGM) signals are always selected.

### ⑤ PST/B bus crosspoint switches [PST/B 1 to 7]

These are used to select the PST/B bus video signals. In the case of the flip-flop system, the images inserted next (PST) are always selected. When a B bus crosspoint switch is pressed while one of the source selector switches (⑥) is held down, key signals or AUX signals are selected.

### ⑥ Source selector switches [SOURCE SELECT/AUX, KEY-S, KEY-F]

When a B bus crosspoint switch (⑤) is pressed while the [AUX] source selector switch is held down, the AUX signals are selected, and when a B bus crosspoint switch (⑤) is pressed while the [KEY-S] or [KEY-F] source selector switch is held down, the key signals are selected.

While a switch is held down, its indicator lights in amber.

In addition, if the [CLN], [PVW] or [PGM] wipe pattern selector switch (⑦) is pressed while the [AUX] switch is held down, the switch will operate as an AUX bus selector switch.

[CLN]: Clean signals are output to the AUX bus. See 3-2-2

[PVW]: PVW signals are output to the AUX bus. See 3-2-2

[PGM]: PGM signals are output to the AUX bus. See 3-2-2

# 1. Functions in each area

## 1-3. Wipe area

### 7 Wipe pattern selector switches [WIPE PATTERN / FUNC]

These are used to select the wipe patterns. Each switch is used to select one of the nine wipe patterns.

The indicator of the switch for the selected pattern lights (in amber).

When the [FUNC] switch (9) has been pressed and its indicator is lighted, the function setting menu is selected, and the indicator lights up green.

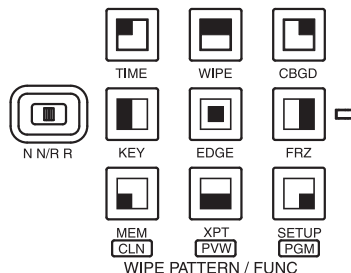

### 8 Wipe direction selector switch [N N/R R]

This is used to select the wipe direction. See 2-2-2

[N]: For setting the wipe direction to the normal direction.

[N/R]: To switch the wipe direction between normal and reverse when the execution of the transition has been completed.

[R]: For setting the wipe direction to the reverse direction.

### 9 [FUNC] switch

When this switch is pressed, its indicator lights up green. If a wipe pattern selector switch is pressed while its indicator is lighted, the wipe pattern selector switch lights up green, and the setting menu of the function indicated underneath the switch appears on the LCD display.

- [TIME]: For setting the auto transition time. See 2-1-5
- [WIPE]: For setting the wipe border and soft effect. See 2-2-3
- [CBGD]: For setting the color background. See 2-4
- [KEY]: For setting the key. See 2-3
- [EDGE]: For setting the key edge. See 2-3-5
- [FRZ]: For displaying the freeze status display and setting freezing. See 2-5
- [MEM]: For setting the preset memory or frame memory. See 2-6, 2-7
- [XPT]: For displaying and setting the crosspoint assignment. See 3-4
- [SETUP]: For performing the system settings. See 3

### 10 Freeze status indicator LED

When this LED is lighted, it means that one of the input signals is frozen.

When the [FUNC] switch (9) is pressed and its indicator is lighted and then the [FRZ] switch is pressed, the freeze status is indicated for each input. (An asterisk (\*) appears above the name of a frozen crosspoint.)

Bear in mind that since the signals are frozen while the indicator is lighted, the unit's output will remain unchanged even if the input images change.

(When crosspoints 3 and 5 are frozen)

|     |  |      |         |
|-----|--|------|---------|
| FRZ |  | FRZ: | * *     |
| 1/2 |  | XPT: | 1234567 |

# 1. Functions in each area

---

## 1-4. Transition area

### 11 [BKGD] switch

This executes the background transition when the [AUTO] switch (16) or fader lever (17) has been operated.

When the [BKGD] switch is pressed and it is selected, its indicator is lighted in amber. If the [KEY] switch (12) is now pressed, the indicator goes off, and the de-selected status is established.

When the [BKGD] switch and [KEY] switch (12) are pressed at the same time, both switches are set to the selected status.

The selection status cannot be changed while a transition is being executed or suspended.

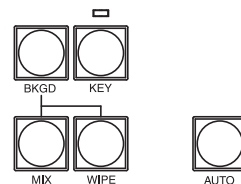

### 12 [KEY] switch

This executes the key transition (MIX) when the [AUTO] switch (16) or fader lever (17) has been operated.

When the [KEY] switch is pressed and it is selected, its indicator lights in amber.

If the [BKGD] switch (11) is now pressed, the indicator goes off, and the de-selected status is established.

When the [BKGD] switch (11) and [KEY] switch are pressed at the same time, both switches are set to the selected status.

The selection status cannot be changed while a transition is being executed or suspended.

### 13 KEY ON tally LED

This lights in red when the key ON status is established.

### 14 [MIX] switch

This is used to switch the A and B bus images while making them overlap.

During the transition, the A and B bus output total is kept at 100 %.

When the [MIX] switch is pressed and it is selected, its indicator lights in amber.

If the [WIPE] switch (15) is now pressed, it goes off, and the de-selected status is established.

### 15 [WIPE] switch

This is used to execute the transition using the pattern selected by the wipe pattern selector switch (7).

When the [WIPE] switch is pressed and it is selected, its indicator lights in amber.

If the [MIX] switch (14) is now pressed, it goes off, and the de-selected status is established.

### 16 [AUTO] switch

This is used to automatically execute transitions (auto transition) using the transition time which has been set.

During auto transition its indicator lights in red. When the switch is pressed again during auto transition, the auto transition operation is suspended, and the indicator lights in green. When it is pressed again while auto transition is suspended, the remaining transition is executed.

The indicator goes off when auto transition is completed.

When the [AUTO] switch is pressed while the fader lever (17) is at an interim position, the remaining transition is executed using the transition time which has been set.

# 1. Functions in each area

---

## 17 Fader lever

This is used to execute background or key transitions. When it is moved as far as it will go, the transition is completed. When it has been operated during auto transition, auto transition will be switched to manual operation as soon as the fader position overtakes the amount of the transition being executed.

## 18 Bus tally LEDs

These indicate the output statuses of the A bus and B bus. The LED corresponding to the bus whose program signals (PGM) are being output lights.

## 1-5. LCD menu area

### 19 LCD

The setting menus are displayed on the LCD.

When the [FUNC] switch (9) is pressed and its indicator is lighted and then one of the wipe pattern selector switches (7) is pressed, the setting menu for the function concerned is displayed.

### 20 Rotary encoders [F1] to [F4]

These are used to set the parameters displayed on the menu.

Menu items are selected and parameters set by rotating [F1] to [F4]. This operation is effective only when the [FUNC] switch is lighting. For details on their operation, refer to the items in “2. Basic operations”.

When the [F1] to [F4] switches are held down, the parameters are returned to their default status. (Numerical value setting items only)

(Startup screen)

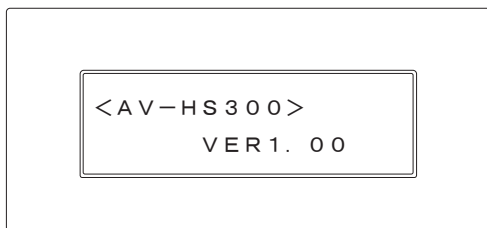

# 1. Functions in each area

## 1-6. Rear panel connections area

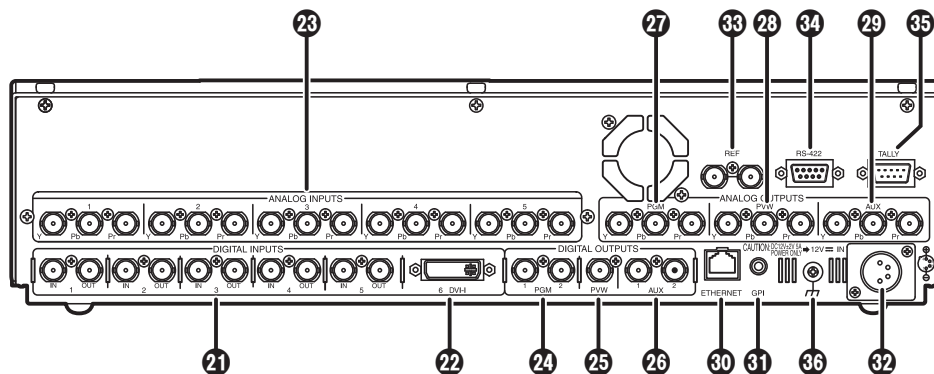

**21 SDI signal input connectors [DIGITAL INPUTS 1 to 5]**

IN: SDI signal input; OUT: active through output

**22 DVI-I signal input connector [DIGITAL INPUTS 6 DVI-I]**

**23 Analog HD component input connectors [ANALOG INPUTS 1 to 5] (optional)**

**24 PGM output connectors [DIGITAL OUTPUTS PGM 1, 2] (SDI)**

**25 PVW output connector [DIGITAL OUTPUTS PVW 1] (SDI)**

**26 AUX output connectors [DIGITAL OUTPUTS AUX 1, 2] (SDI)**

**27 PGM output connector [ANALOG OUTPUTS PGM 1] (analog HD component)**

**28 PVW output connector [ANALOG OUTPUTS PVW 1] (analog HD component)**

**29 AUX output connector [ANALOG OUTPUTS AUX 1] (analog HD component)**

**30 Ethernet port [ETHERNET] (10BASE-T, 100BASE-TX)**

**31 GPI input connector [GPI] (auto take)**

For details on connection, refer to “6. External interfaces”.

**32 DC power socket [12V=IN]**

The DC 12 V voltage is supplied to this socket.  
Use the AW-PS505A AC adaptor.

**Note**

When using other power sources, make sure the output is DC 12 V  $\pm$ 2 V, 5 A.

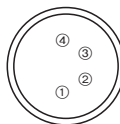

| Pin No. | Signal name |
|---------|-------------|
| 1       | GND         |
| 2       | NC          |
| 3       | NC          |
| 4       | DC12V       |

**33 Reference input connector/BB output connector [REF]**

Loop-through output in the external sync mode.  
BB signals output from both connectors in the internal sync mode.

**34 RS-422 interface connector [RS-422]**

For details on connection, refer to “6. External interfaces”.

**35 Tally output connector [TALLY]**

For details on connection, refer to “6. External interfaces”.

**36 Ground connector**

Connect to the system’s earth ground.

# 2. Basic operations

## 2-1. Transitions

### 2-1-1. Selecting the bus

Press the crosspoint switches to select the material which will be targeted for the background transition. By pressing these switches, the signals are selected, and the indicators of the selected switches light. The color in which the switch indicators light differs depending on the operation status.

**Lighting in red:** When the selected input signals are output to PGM.

**Lighting in green:** When the selected input signals are not output to PGM.

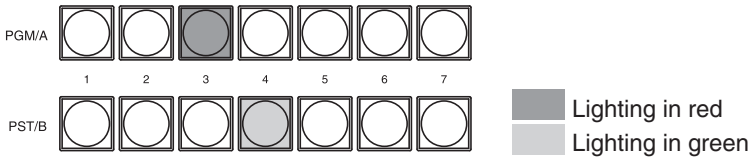

For details on how to select the key source bus and key fill bus, refer to “2-3-1” and “2-3-4”.  
For details on how to select the AUX bus, refer to “3-2-2”.

### 2-1-2. Selecting the bus mode

Select the A/B bus system or flip-flop system (PGM/PST system) from the setting menu.

- ① Press the [FUNC] switch to light its indicator, and then press the [SETUP] switch to display the SETUP menu.
- ② Turn [F1] to display the BUS menu.
- ③ Turn [F2], and select the A/B or P/P (PGM/PST system) using the MODE item.

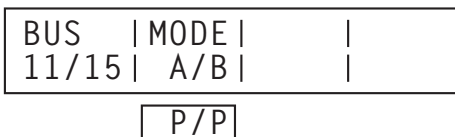

With the flip-flop (P/P) system, the PGM/A bus selected signals are always output as PGM images, and the PST/B bus selected signals are always output as PVW (PST) images.

| System | Video output | Before transition | During transition | After transition completion |
|--------|--------------|-------------------|-------------------|-----------------------------|
| A/B    | PGM          | PGM/A             | PGM/A, PST/B      | PST/B                       |
|        | PVW (PST)    | PST/B             | PST/B             | PGM/A                       |

- With an A → B transition

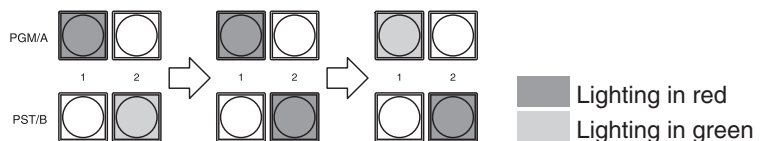

| System        | Video output | Before transition | During transition | After transition completion |
|---------------|--------------|-------------------|-------------------|-----------------------------|
| Flip-flop P/P | PGM          | PGM/A             | PGM/A, PST/B      | PGM/A                       |
|               | PVW (PST)    | PST/B             | PST/B             | PST/B                       |

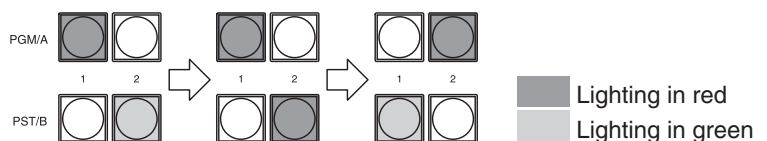

## 2. Basic operations

---

### 2-1-3. Selecting the transition mode

Use the [BKGD] and [KEY] switches in the transition area to select the bus signals for which the transition is to be executed. If the switches have been pressed at the same time, both switches are selected. The indicator of a selected switch lights in amber.

The switches cannot be selected while a transition is being executed or suspended.

Use the [MIX] and [WIPE] switches in the transition area to select the background transition mode. Select one of these switches, and the indicator of the selected switch lights in amber.

MIX always applies to key transitions whichever switch has been selected.

### 2-1-4. Manual transition (using the fader lever)

Operate the fader lever to execute transitions manually.

If the fader lever has been operated during auto transition, auto transition will be switched to manual operation as soon as the fader position overtakes the amount of the transition being executed.

The bus tally LEDs on the left of the fader lever indicate the program bus output status.

- Top LED only lights:** PGM/A bus output
- Top and bottom LEDs light:** PGM/A, PST/B output (during the transition)
- Bottom LED only lights:** PST/B output

### 2-1-5. Auto transition

- When the [AUTO] switch is pressed, the transition is executed automatically using the transition time which has been set.
- If the [AUTO] switch is pressed while the fader lever is at a midway position, the remaining transition will be executed automatically using the transition time which has been set.
- The auto transition time is set using the menu. It can be set separately for BKGD and KEY.
  - ① Press the [FUNC] switch to light its indicator, and press the [TIME] switch to display the TIME menu.
  - ② Turn [F1] to display the BKGD or KEY menu.
  - ③ Turn [F4] to select the display unit using the UNIT item.
  - ④ When frames (F) have been selected as the unit, turn [F2] or [F3] to set the transition time.
  - ⑤ When seconds (SEC) have been selected as the unit, turn [F2] to set the second units or [F3] to set the frame units.

(With BKGD and seconds (SEC) as the display unit)

|      |  |           |  |           |
|------|--|-----------|--|-----------|
| BKGD |  | TRANSTIME |  | UNIT      |
| 1/2  |  | 16s       |  | 39f   SEC |

(With KEY and frames (F) as the display unit)

|     |  |           |  |      |
|-----|--|-----------|--|------|
| KEY |  | TRANSTIME |  | UNIT |
| 2/2 |  | 999f      |  | F    |

- Any time from 0 to 999f can be set. The time which can be set when seconds are used as the display unit differs depending on the video format.
  - 59i:** max. 33s09f, **59p:** max. 16s39f
  - 50i:** max. 39s24f, **50p:** max. 19s49f

# 2. Basic operations

## 2-2. Wipe

### 2-2-1. Selecting the wipe pattern

Press one of the wipe pattern selector switches to select the desired wipe pattern from among the nine patterns available. The indicator of the selected wipe pattern selector switch lights in amber.

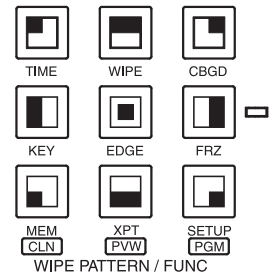

### 2-2-2. Selecting the wipe direction

Operate the transition direction selector switch (DIP switch) to select the wipe direction.

**N:** For setting the wipe direction to the normal direction.

**N/R:** To switch the wipe direction between normal and reverse when the execution of the transition has been completed.

**R:** For setting the wipe direction to the reverse direction.

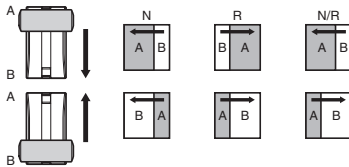

### 2-2-3. Wipe decorations (border, soft effect)

#### ■ Adding borders

Borders can be added to the wipe edges.

- ① Press the [FUNC] switch to light its indicator, and then press the [WIPE] switch to display the WIPE menu. The BODR menu appears first.
- ② Turn [F2], and set the width of the border using the WIDT item. A setting of "0" means that the border is OFF.

|      |      |      |      |
|------|------|------|------|
| BODR | WIDT | SOFT | COLR |
| 1/5  | 0    | 0    | WHT  |

|       |       |                  |
|-------|-------|------------------|
| 0-255 | 0-255 | Y<br>L<br>W      |
|       |       | C<br>Y<br>N      |
|       |       | G<br>R<br>N      |
|       |       | M<br>G<br>T      |
|       |       | R<br>E<br>D      |
|       |       | B<br>L<br>E      |
|       |       | B<br>L<br>K      |
|       |       | U<br>S<br>R<br>1 |
|       |       | U<br>S<br>R<br>2 |
|       |       | U<br>S<br>R<br>3 |
|       |       | U<br>S<br>R<br>4 |



## 2. Basic operations

---

### ■ Changing the soft effect amount

On the BODR menu, turn [F3], and set the soft effect amount using the SOFT item.  
A setting of “0” means that the soft effect is OFF.

### ■ Setting the border color

On the BODR menu, turn [F4], and set the border color using the COLR item.  
When USR1 to 4 (user colors) has been selected, the color can be adjusted on the USR1 to 4 menu.

### ■ Adjusting the border color

When USR1, 2, 3 or 4 has been selected, the border color can be adjusted.  
Use of USR1 to 4 is shared by the color background, fill color and edge color.

- ① Press the [FUNC] switch to light its indicator, and then press the [WIPE] switch to display the WIPE menu.
- ② Turn [F1] to display the USR1 to 4 (user color) menu.
- ③ Turn [F2], [F3] or [F4] to adjust the color (HUE, SAT or LUM).

|       |       |       |     |
|-------|-------|-------|-----|
| USR1  | HUE   | SAT   | LUM |
| 2/5   | 0     | 0     | 100 |
| 0-359 | 0-100 | 0-108 |     |

| Operation | Parameter | Description of setting | Setting range |
|-----------|-----------|------------------------|---------------|
| F2        | HUE       | Hue                    | 0 to 359      |
| F3        | SAT       | Saturation             | 0 to 100      |
| F4        | LUM       | Luminance              | 0 to 108      |

## 2. Basic operations

### 2-3. Key

#### 2-3-1. Selecting the key source

##### ■Selecting the key source signals

The signals assigned to crosspoints 1 to 7 can be used for the key source signals. While holding down the [KEY-S] switch in the source selection area, press one of the B bus crosspoint switches [1] to [7] to select the key source signal. The indicators of the [KEY-S] switch and selected crosspoint switch light in amber.

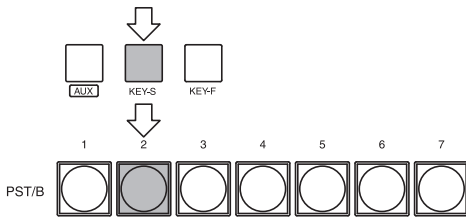

Provide materials with white key-combined characters or patterns on a black background for the key source signals. The keys may not be combined satisfactorily if the material has colors other than black and white. Material with black characters on a white background, for example, can be reversed for use using the key invert function.

##### <How key composition works>

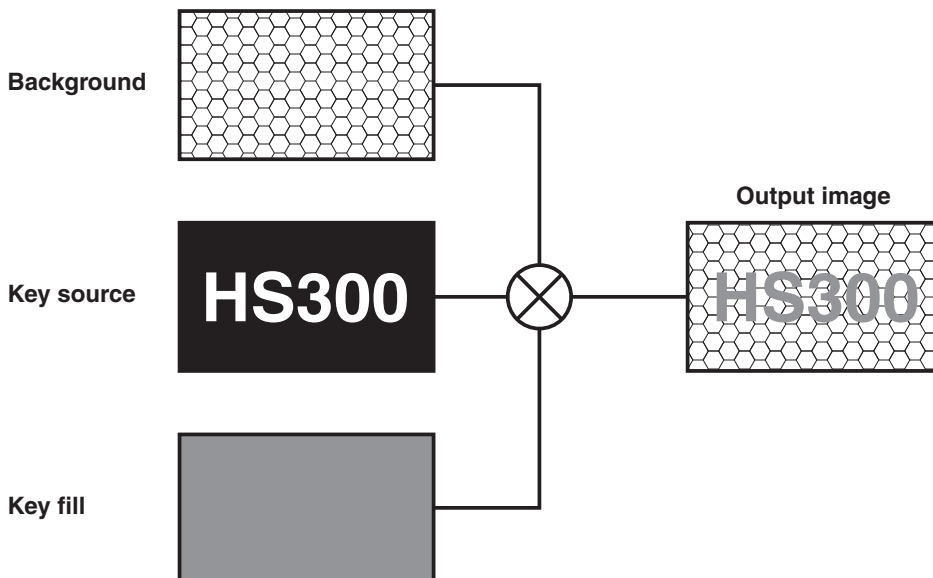

## 2. Basic operations

### 2-3-2. Setting the key

#### ■Selecting the key type

- ① Press the [FUNC] switch to light its indicator, and then press the [KEY] switch to display the KEY menu.
- ② Turn [F1] to display the KEY menu (sub menu).
- ③ Turn [F2], and select the TYPE item.

**SELF (self key/luminance key):** The key signals are created from the luminance signals of the key fill material. Since key fill signals are used as the key source, the signals selected by the key source are ignored.

**LIN (linear key/EXT key):** The key signals are created from the luminance signals of the key source.

| TYPE                          | KEY FILL              | KEY SOURCE       |
|-------------------------------|-----------------------|------------------|
| SELF (self key/luminance key) | XPT1 to 7, FILL COLOR | Same as KEY FILL |
| LIN (linear key/EXT key)      | XPT1 to 7, FILL COLOR | XPT1 to 7        |

|     |  |      |  |     |  |      |
|-----|--|------|--|-----|--|------|
| KEY |  | TYPE |  | INV |  | PVW  |
| 1/7 |  | LIN  |  | OFF |  | AUTO |

|      |    |           |
|------|----|-----------|
| SELF | ON | ON<br>OFF |
|------|----|-----------|

#### ■Setting key invert

On the KEY menu (sub menu), turn [F3], and set to the key invert ON or OFF using the INV item.

#### ■Selecting key preview

Select whether to display the key preview for the PVW output.

On the KEY menu (sub menu), turn [F4] and set the PVW item.

**ON:** Images with key effects added are output to PVW.

**OFF:** Images with no key effects added are output to PVW.

**AUTO:** Preview images of the next transition are output to PVW.

### 2-3-3. Key adjustments

Adjust the key definition.

- ① Press the [FUNC] switch to light its indicator, and then press the [KEY] switch to display the KEY menu.
- ② Turn [F1] to display the K-ADJ menu.
- ③ Turn [F2], [F3] and [F4] to adjust the key definition.

|       |  |      |  |      |  |      |
|-------|--|------|--|------|--|------|
| K-ADJ |  | CLIP |  | GAIN |  | DENS |
| 2/7   |  | 0    |  | 100  |  | 100  |

|       |       |       |
|-------|-------|-------|
| 0-108 | 0-200 | 0-100 |
|-------|-------|-------|

| Operation | Parameter | Description of setting                   | Setting range |
|-----------|-----------|--|---------------|
| F2        | CLIP      | Reference level for creating key signals | 0 to 108      |
| F3        | GAIN      | Key gain                                 | 0 to 200      |
| F4        | DENS      | Key density                              | 0 to 100      |

## 2. Basic operations

### 2-3-4. Selecting key fill

#### ■Selecting the key fill signals

In addition to the signals assigned to crosspoints 1 to 7, special fill colors can be used for the key fill signals. While holding down the [KEY-F] switch in the source selection area, press one of the B bus crosspoint switches 1 to 7 to select the key fill signal. The indicators of the [KEY-F] switch and selected crosspoint switch light (in amber). Bus images are not used when the fill color has been selected on the menu.

When the [KEY-F] switch in the source selection area is pressed, the menu display is switched to the FILL menu, and the fill color can now be selected.

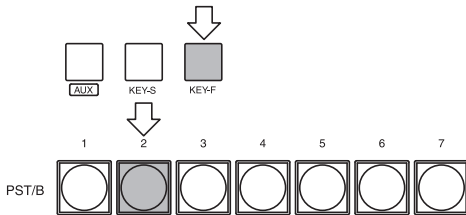

#### ■Selecting the fill color

The fill color is selected on the menu.

- ① Press the [FUNC] switch to light its indicator, and then press the [KEY] switch to display the KEY menu.
- ② Turn [F1] to display the FILL menu.
- ③ Turn [F2], and select COLR (special fill color) from the TYPE item.
- ④ Turn [F3], and select the fill color from the COLR item.

|      |  |      |  |      |  |
|------|--|------|--|------|--|
| FILL |  | TYPE |  | COLR |  |
| 3/7  |  | BUS  |  | WHT  |  |

|      |   |   |   |   |
|------|---|---|---|---|
| COLR | Y | L | W |   |
|      | C | Y | N |   |
|      | G | R | N |   |
|      | M | G | T |   |
|      | R | E | D |   |
|      | B | L | E |   |
|      | B | L | K |   |
|      | U | S | R | 1 |
|      | U | S | R | 2 |
|      | U | S | R | 3 |
|      | U | S | R | 4 |

## 2. Basic operations

### ■ Adjusting the fill color

The fill color can be adjusted when USR1 to 4 have been selected. Use of USR1 to 4 is shared by the border color, color background and edge color.

- ① Press the [FUNC] switch to light its indicator, and then press the [KEY] switch to display the KEY menu.
- ② Turn [F1] to display the USR1 to 4 (user color) menu.
- ③ Turn [F2], [F3] and [F4] to adjust the color (HUE, SAT and LUM).

|      |     |     |     |
|------|-----|-----|-----|
| USR1 | HUE | SAT | LUM |
| 4/7  | 0   | 0   | 100 |

|       |       |       |
|-------|-------|-------|
| 0-359 | 0-100 | 0-108 |
|-------|-------|-------|

### 2-3-5. Key decorations

#### ■ Setting the key edge

A border, shadow or other edge can be added to the key.

- ① Press the [FUNC] switch to light its indicator, and then press the [EDGE] switch to display the EDGE menu. The EDGE menu (sub menu) appears first.
- ② Turn [F2] to select the edge type.
  - OFF:** An edge is not added.
  - BODR (BORDER):** A border is added around the entire edge.
  - DROP:** A diagonal border is added but only in the direction toward the bottom right of the key.
  - SHDW (SHADOW):** A shadow is added but only in the direction toward the bottom right of the key.
  - OUTL (OUTLINE):** An outline (only a border with no fill) is added.
- ③ Turn [F3] to set the edge width.
- ④ Turn [F4] to select the edge color.

|      |      |      |      |
|------|------|------|------|
| EDGE | TYPE | WIDT | COLR |
| 1/5  | OFF  | 2    | WHT  |

|      |     |      |
|------|-----|------|
| BODR | 0-4 | YLW  |
| DROP |     | CYN  |
| SHDW |     | GRN  |
| OUTL |     | MGT  |
|      |     | RED  |
|      |     | BLE  |
|      |     | BLK  |
|      |     | USR1 |
|      |     | USR2 |
|      |     | USR3 |
|      |     | USR4 |

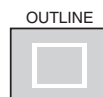
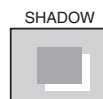
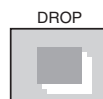
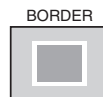

## 2. Basic operations

---

### ■ Adjusting the edge color

The edge color can be adjusted when USR1, 2, 3 or 4 has been selected. Use of USR1 to 4 is shared by the border color, color background and fill color.

- ① Press the [FUNC] switch to light its indicator, and then press the [EDGE] switch to display the EDGE menu.
- ② Turn [F1] to display the USR1 to 4 (user color) menu.
- ③ Turn [F2], [F3] and [F4] to adjust the color (HUE, SAT and LUM).

|      |     |     |     |
|------|-----|-----|-----|
| USR1 | HUE | SAT | LUM |
| 2/5  | 0   | 0   | 100 |

|       |       |       |
|-------|-------|-------|
| 0-359 | 0-100 | 0-108 |
|-------|-------|-------|

## 2. Basic operations

---

### 2-4. Color background

The color background to be used by the bus can be set.

One color among the eight preset colors (WHITE, YELLOW, CYAN, GREEN, MAGENTA, RED, BLUE and BLACK) and four user colors can be selected. HUE, SAT and LUM adjustments can be performed for the user colors.

- ① Press the [FUNC] switch to light its indicator, and then press the [CBGD] switch to display the CBGD menu.
- ② Turn [F2], and select the color using the COLR item.

|      |  |      |  |
|------|--|------|--|
| CBGD |  | COLR |  |
| 1/5  |  | WHT  |  |

|      |
|------|
| YLW  |
| CYN  |
| GRN  |
| MGT  |
| RED  |
| BLE  |
| BLK  |
| USR1 |
| USR2 |
| USR3 |
| USR4 |

#### ■ Adjusting the color background

The background color can be adjusted when USR1, 2, 3 or 4 has been selected. Use of USR1 to 4 is shared by the border color, color background, fill color and edge color.

- ① On the [CBGD] menu, turn [F1] to display the USR1 to 4 (user color) menu.
- ② Turn [F2], [F3] and [F4] to adjust the color (HUE, SAT and LUM).

|      |  |     |  |     |  |     |
|------|--|-----|--|-----|--|-----|
| USR1 |  | HUE |  | SAT |  | LUM |
| 2/5  |  | 0   |  | 0   |  | 100 |

|       |       |       |
|-------|-------|-------|
| 0-359 | 0-100 | 0-108 |
|-------|-------|-------|

## 2. Basic operations

---

### 2-5. Freezing the input signals

The input signals can be frozen and used. If any of the input signals has been frozen, the freeze status display LED lights. While signals are frozen, the tally signals of the corresponding input will not be output.

- ① Press the [FUNC] switch to light its indicator, and then press the [FRZ] switch to display the FRZ menu.
- ② Turn [F1] to display the FRZ (2/2) menu.
- ③ Turn [F2], and select the input video signals using the SIG item.
- ④ Press the [F4] switch to freeze or de-freeze the input image. If it is pressed when the display shows "OFF", the input image is frozen, and the display shows "ON". If it is pressed when the display shows "ON", the input image is de-frozen, and the display shows "OFF".

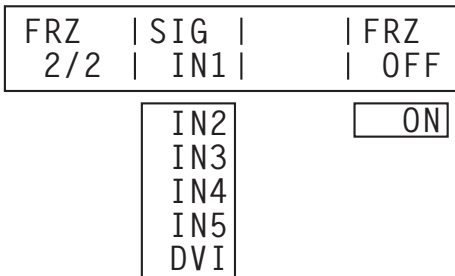

When the unit is used with the frame synchronizer function OFF, the output images may be disturbed when freezing is executed, but the frozen images will not be adversely affected. The frame synchronizer function will automatically be switched ON.



## 2. Basic operations

---

### 2-6. Frame memory

AUX output signals can be stored in the frame memory for use. Stored images can be used as the bus images by assigning the FMEM signals using the crosspoint assignment process.

Images stored in the frame memory are also saved in the unit's flash memory so they can be used even after the power is turned off. Stored images have an 8-bit format so the image quality may appear rough at times.

- ① Press the [FUNC] switch to light its indicator, and then press the [MEM] switch to display the MEM menu.
- ② Turn [F1] to display the MEM menu.
- ③ Press the [F4] switch (EXEC) to store the still images in the frame memory.

|      |  |     |  |      |  |      |
|------|--|-----|--|------|--|------|
| FMEM |  | SIG |  | MEM  |  | STOR |
| 3/3  |  | AUX |  | FMEM |  | EXEC |

Images can also be captured into the frame memory from a PC via Ethernet.  
For details on how to transmit them, refer to "5. Image transmission functions".

## 2. Basic operations

### 2-7. Preset memory

Up to 10 panel settings can be stored in this memory.  
The table below lists the settings which are stored.

<Table of stored preset memory>

| Item                   | Description of setting       | Initial value (factory default)   |
|------------------------|------------------------------|-----------------------------------|
| <b>Crosspoint</b>      | A bus                        | 1                                 |
|                        | B bus                        | 1                                 |
|                        | KEY-S                        | 1                                 |
|                        | KEY-F                        | 1                                 |
|                        | AUX bus                      | 1                                 |
|                        | Color background             | WHITE                             |
| <b>Wipe</b>            | Wipe pattern                 | 4 (center)                        |
|                        | Border width                 | 0                                 |
|                        | Soft effect width            | 0                                 |
|                        | Border color                 | WHT                               |
| <b>Transition area</b> | BKGD/KEY selection           | BKGD                              |
|                        | MIX/WIPE selection           | MIX                               |
|                        | Auto transition time (BKGD)  | 30F                               |
|                        | Auto transition time (KEY)   | 30F                               |
| <b>Key</b>             | Key type (TYPE)              | LIN                               |
|                        | Key adjustment (ADJ)         | GAIN: 100<br>CLIP: 0<br>DENS: 100 |
|                        | Invert ON/OFF                | OFF                               |
|                        | Fill color                   | BLE                               |
|                        | Edge color                   | YLW                               |
|                        | Edge ON/OFF (TYPE)           | OFF                               |
|                        | Edge width                   | 2                                 |
| <b>User color</b>      | User color 1 (HUE, SAT, LUM) | 0, 0, 100                         |
|                        | User color 2 (HUE, SAT, LUM) | 355, 100, 7                       |
|                        | User color 3 (HUE, SAT, LUM) | 50, 100, 29                       |
|                        | User color 4 (HUE, SAT, LUM) | 0, 0, 0                           |

• The data stored in the preset memory will not be initialized even when initializing is performed.

**STORE:** This is used to store the panel settings in the preset memory.

- ① Press the [FUNC] switch to light its indicator, and then press the [MEM] switch to display the MEM menu.  
The PSMEM (1/3) menu appears first.
- ② Turn [F2], select "STOR" using the MODE item, turn [F3], and set the preset memory number using the NO. item.
- ③ Press the [F4] switch (EXEC) to store the settings.

```
PSMEM | MODE | NO. |
1/3 | STOR | 1 | EXEC
```

```
RECL | 1-10
CLR
```

An asterisk (\*) appears at the left of the number when data has been saved in the preset memory.

## 2. Basic operations

---

**RECALL: This is used to recall the preset memory data and change the panel settings.**

- ① Press the [FUNC] switch to light its indicator, and then press the [MEM] switch to display the PSMEM (1/3) menu.
- ② Turn [F2], select "RECL" using the MODE item, turn [F3], and set the preset memory number using the NO. item.
- ③ Press the [F4] switch (EXEC) to recall the settings.  
If the asterisk (\*) is not displayed at the left of the preset memory number, the panel status will remain unchanged even when the settings in the preset memory are recalled.

Recall settings can be selected for the crosspoint settings.

**ENBL:** The data stored in the preset memory is used.

**DSBL:** The data stored in the preset memory is not used, and the settings prior to recall are retained.

- ① Press the [FUNC] switch to light its indicator, and then press the [MEM] switch to display the PSMEM (1/3) menu.
- ② Turn [F1] to display the PSMEM (2/3) menu.
- ③ Turn [F2], and select crosspoint disable (DSBL) or enable (ENBL) using the XPT item.

|              |
|--------------|
| PSMEM   XPT  |
| 2 / 3   DSBL |

|      |
|------|
| ENBL |
|------|

**CLEAR: This is used to clear contents in the preset memory.**

- ① Press the [FUNC] switch to light its indicator, and then press the [MEM] switch to display the PSMEM (1/3) menu.
- ② Turn [F2], select "CLR" using the MODE item, turn [F3], and set the preset memory number using the NO. item.
- ③ Press the [F4] switch (EXEC) to clear the content.  
When the memory settings are cleared, the asterisk (\*) at the left of the preset memory number will not be displayed.

# 3. Setup

## 3-1. Setting the input signals

### 3-1-1. Setting the input signals (IN 1 to 5)

If HD has been selected as the system format, SDI or analog HD component can be selected for each input. This selection is possible only when the HD analog board has been connected.

- ① Press the [FUNC] switch to light its indicator, and then press the [SETUP] switch to display the SETUP menu.
- ② Turn [F1] to display the IN1 to 5 menu.
- ③ Turn [F2], select the input signals using the SIG item, turn [F3], and select SDI or ANLG (analog HD component) using the MODE item.
- ④ If analog HD component has been selected, turn [F4], and set the gain of the input signals using the GAIN item. The gain can be set within the  $\pm 30$ -step range, and the setting will result in changes of  $\pm 2$  dB. The amount by which the gain changes per step is not the same for each step.

|       |     |      |      |
|-------|-----|------|------|
| IN1-5 | SIG | MODE | GAIN |
| 1/15  | IN1 | SDI  | -    |

|     |      |        |
|-----|------|--------|
| IN2 | ANLG | -30-30 |
| IN3 |      |        |
| IN4 |      |        |
| IN5 |      |        |

### 3-1-2. Setting the input signal frame synchronizer

The frame synchronizer can be set to ON or OFF for each input.

The input 6 (DVI input) frame synchronizer is permanently ON. It cannot be set from ON to OFF or vice versa.

- ① Press the [FUNC] switch to light its indicator, and then press the [SETUP] switch to display the SETUP menu.
- ② Turn [F1] to display the FS menu.
- ③ Turn [F2], select the input signals using the SIG item, turn [F3], and select ON or OFF for the frame synchronizer using the FS item.

|      |     |    |
|------|-----|----|
| FS   | SIG | FS |
| 3/15 | IN1 | ON |

|     |     |
|-----|-----|
| IN2 | OFF |
| IN3 |     |
| IN4 |     |
| IN5 |     |

AVDL function is active while the frame synchronizer function is set to OFF.

The AVDL function automatically adjusts the input image signal phase to the horizontal synchronization reference signal phase.

For details, refer to "3-6. Adjusting the output signal phase".

# 3. Setup

## 3-1-3. Setting the DVI input signals (IN6)

### ■Selecting the signal system

Select the digital or analog system for the DVI input video signals.

**DIG (digital):** Digital input signals of the DVI connector are effective.

**ANLG (analog):** Analog input signals of the DVI connector are effective.

- ① Press the [FUNC] switch to light its indicator, and then press the [SETUP] switch to display the SETUP menu.
- ② Turn [F1] to display the DVIIN menu.
- ③ Turn [F2], and select the signal system using the MODE item.



### ■Selecting the scaling method







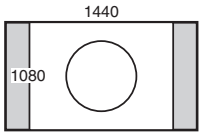
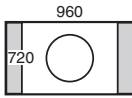

XGA or SXGA can be input as the size. The frequency is fixed at 60 Hz.

**NORM (normal):** The size of the input images is increased or reduced while keeping their aspect ratio the same.

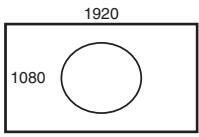
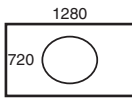
**FULL (full):** The size of the input images is increased or reduced in accordance with the system resolution. (The aspect ratio of the input images is not kept the same. The rate at which the image size is increased or reduced in the vertical direction and in the horizontal direction differs.)

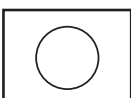
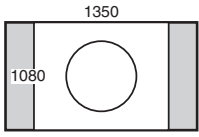
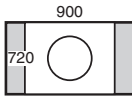
On the DVIIN menu, turn [F3], and select the scaling method using the SCAL item.

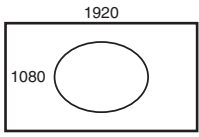
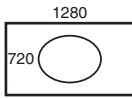
### <DVI input scaling size table>

| DVI format  | Mode | HD/1080i  | HD/720P   | SD/NTSC*1  | SD/PAL*2  |
|---|------|---|---|--|---|
|   |      | 1920 × 1080   | 1280 × 720  | 720 × 480  | 720 × 576   |
| <b>XGA</b><br>1024 × 768<br>   | NORM |  |  |  |  |
|   | FULL |  |  |  |  |
| <b>SXGA</b><br>1280 × 1024<br> | NORM |  |  |  |  |
|   | FULL |  |  |  |  |

# 3. Setup

---

## ■ Adjustment

Adjust the clock/phase and position of the DVI input signals.

- ① Press the [FUNC] switch to light its indicator, and then press the [SETUP] switch to display the SETUP menu.
- ② Turn [F1] to display the DVIPH menu.
- ③ Turn [F2] to adjust the clock/phase of the analog input signal using the CKPH item.  
Adjust this setting so that the noise will be minimum level.
- ④ Turn [F3] to adjust the horizontal position using the HPOS item.
- ⑤ Turn [F4] to adjust the vertical position using the VPOS item.

|        |          |          |      |
|--------|----------|----------|------|
| DVIPH  | CKPH     | HPOS     | VPOS |
| 13/15  | 0        | 0        | 0    |
| -16-15 | -100-100 | -100-100 |      |

# 3. Setup

---

## 3-2. Setting the output signals

### 3-2-1. Types of output signals

There are three output signal types: PGM, PVW and AUX.

**PGM:** This is the main-line output of the switcher; images with wipe, mix, key and other effects added to them are output.

**PVW:** This is the preview output which enables the next operation to be checked in advance.

**AUX:** Signals selected by the AUX bus are output.

### 3-2-2. Selecting the AUX signals

One of the crosspoints 1 to 7, PGM, PVW or CLN signals can be selected for the AUX bus.

To select a crosspoint signal, press one of the B crosspoint switches 1 to 7 while holding down the [AUX] switch. The indicator of the selected switch lights (in amber), and the images are switched.

To select PGM, PVW or CLN signals, press one of the wipe pattern selector switches while holding down the [AUX] switch. The indicator of the selected switch lights (in amber), and the images are switched.

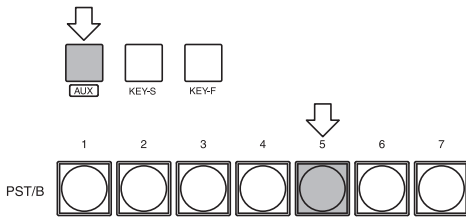

When CLN signals have been selected, images with the key signals removed from the PGM signals are output.

# 3. Setup

---

## 3-3. Selecting the video format

One system (input/output signal) video format can be selected. More than one format cannot be selected. If HD is selected, SDI or HD analog component can be selected for each input. (See 3-1-1)

- ① Press the [FUNC] switch to light its indicator, and then press the [SETUP] switch to display the SETUP menu.
- ② Turn [F1] to display the FORMT menu.
- ③ Turn [F2], select the format using the MODE item, and press the [F4] switch (EXEC) to enter the selection. An asterisk (\*) appears at the left of the format currently selected.

```
FORMT | MODE |  
4/15 | *1080/59i | EXEC
```

```
1080/50i  
720/59p  
720/50p  
480/59i  
576/50i
```

| Display  | HD/SD | Signal format | Input signals             |
|----------|-------|---------------|---------------------------|
| 1080/59i | HD    | 1080/59.94i   | SDI / analog HD component |
| 1080/50i | HD    | 1080/50i      | SDI / analog HD component |
| 720/59p  | HD    | 720/59.94p    | SDI / analog HD component |
| 720/50p  | HD    | 720/50p       | SDI / analog HD component |
| 480/59i  | SD    | 480/59.94i    | SDI                       |
| 576/50i  | SD    | 576/50i       | SDI                       |



# 3. Setup

## 3-4. Setting the crosspoints

### 3-4-1. Assigning signals to the crosspoints

External video input signals and internally generated signals can be assigned to crosspoint switches 1 to 7.

#### ■Displaying the assignment statuses

- ① Press the [FUNC] switch to light its indicator, and then press the [XPT] switch to display the XPT menu.
- ② The XPTAS (1/3) menu appears first, and the assignment statuses are displayed. The names of the assigned signals are abbreviated on the display.

```
XPTAS | SIG: B12345D
1/3   | XPT: 1234567
```

When one of the crosspoint switches 1 to 7 is held down for a long time, the name of the signal assigned is displayed on the LCD while the button is held down.

Example: When crosspoint switch 1 is pressed (when the black signal has been assigned to this switch).

```
XPTAS | SIG: BLK
      | XPT: 1
```

#### ■Assigning signals to the crosspoints

- ① Press the [FUNC] switch to light its indicator, and then press the [XPT] switch to display the XPT menu.
- ② Turn [F1] to display the XPTAS (2/3) menu.
- ③ Turn [F2], select the crosspoint switch using the XPT item, turn [F3] and select the input signal using the SIG item.

```
XPTAS | XPT | SIG |
2/3   | 1 | IN1 |
```

```
2 | IN2
3 | IN3
4 | IN4
5 | IN5
6 | DVI
7 | BLK
  | CBGD
  | CBAR
  | FMEM
```

The table below lists the materials which can be assigned.

| Switch   | Signal           | Abbreviation |        | Description   |
|----------|------------------|--------------|--------|---|
| XP1 to 7 | INPUT1 to 5      | IN1 to 5     | 1 to 5 | SDI or analog HD component                            |
|          | DVIIN            | DVI          | D      | DVI-I input   |
|          | BLACK            | BLK          | B      | Internally generated signal, black                    |
|          | COLOR BACKGROUND | CBGD         | G      | Internally generated signal, color background (matte) |
|          | COLOR BAR        | CBAR         | C      | Internally generated signal, color bar                |
|          | FRAME MEMORY     | FMEM         | F      | Frame memory image                                    |

# 3. Setup

---

The table below lists the default settings.

| Switch | Signal | Description  |
|--------|--------|--|
| XP1    | BLACK  | Internally generated signal, black                 |
| XP2    | INPUT1 | External video input 1: SDI or analog HD component |
| XP3    | INPUT2 | External video input 2: SDI or analog HD component |
| XP4    | INPUT3 | External video input 3: SDI or analog HD component |
| XP5    | INPUT4 | External video input 4: SDI or analog HD component |
| XP6    | INPUT5 | External video input 5: SDI or analog HD component |
| XP7    | DVIIN  | External video input 6: DVI-I input                |

## 3-4-2. Setting the crosspoint switching

The timing at which the crosspoints are to be switched can be set.

**ANY:** The crosspoints are switched in the nearest field. This is suited to live applications.

**F1:** The crosspoints are switched in field 1. This is suited to editing applications.

**F2:** The crosspoints are switched in field 2. This is suited to editing applications.

- ① Press the [FUNC] switch to light its indicator, and then press the [XPT] switch to display the XPT menu.
- ② Turn [F1] to display the XPTSW menu.
- ③ Turn [F2], and select the switching timing using the TIMG item.

|              |
|--------------|
| XPTSW   TIMG |
| 3/3   ANY    |

|    |
|----|
| F1 |
| F2 |

# 3. Setup

---

## 3-5. Setting the sync signals

The sync signals to be used by the system can be selected.

**External sync:** For synchronization with an external sync signal (gen-lock). The reference input signal is looped through and output.

**BBST:** Black burst signal (vertical phase of 0H)

**BBAD:** Black burst signal

This can be selected when HD format signals are supplied.  
(Vertical phase of 90H when the 59.94i or 59.94p format is selected;  
vertical phase of 75H when the 50i or 50p format is selected)

**TRI:** Tri-level sync signal (vertical phase of 0H)

This can be selected when HD format signals are supplied.

**Internal sync:** For synchronization with an internal reference signal (INT). The REFOUT signal (black burst signal) is output from the two reference connectors.

- ① Press the [FUNC] switch to light its indicator, and then press the [SETUP] switch to display the SETUP menu.
- ② Turn [F1] to display the REF menu.
- ③ Turn [F2], select the sync signal using the SYNC item, and press the [F4] switch (EXEC) to enter the selection.  
An asterisk (\*) appears at the left of the reference signal currently selected.

|      |  |       |  |    |  |      |
|------|--|-------|--|----|--|------|
| REF  |  | SYNC  |  | GL |  |      |
| 5/15 |  | *BBST |  | *  |  | EXEC |

|      |  |   |
|------|--|---|
| BBAD |  | - |
| TRI  |  |   |
| INT  |  |   |

An asterisk (\*) appears at the GL item when operation is synchronized with the external or internal sync signals.

A dash (-) appears at the GL item when operation is not synchronized with the external or internal sync signals.

# 3. Setup

---

## 3-6. Adjusting the output signal phase

The phase of the output video signals can be adjusted.

- ① Press the [FUNC] switch to light its indicator, and then press the [SETUP] switch to display the SETUP menu.
- ② Turn [F1] to display the OUPHS menu.
- ③ Turn [F2], and select 0H or 1H using the SYS item.  
**0H:** The output video signals are output to the system REF signal with using in-phase.  
The frame synchronizer function is ON for all input signals.  
**1H:** The output video signals are output to the system REF signal with 1H delay.
- ④ Turn [F3] to adjust H phase using the HPHS item, and turn [F4] to adjust V phase using the VPHS item.  
HPHS can be adjusted within a range of  $-0.5H$  to  $+0.5H$  and VPHS within a range of  $-100H$  to  $+100H$ .

|       |     |      |      |
|-------|-----|------|------|
| OUPHS | SYS | HPHS | VPHS |
| 6/15  | 1H  | 0    | 0    |

|    |
|----|
| 0H |
|----|

### Output video signal phase adjustment

| Phase  | Video format         | Adjustment range |
|--------|----------------------|------------------|
| HPHASE | 1080i/59i            | -1100 to 1099    |
|        | 1080/50i             | -1320 to 1319    |
|        | 720/59p              | -825 to 824      |
|        | 720/50p              | -990 to 989      |
|        | 480/59i              | -429 to 428      |
|        | 576/50i              | -432 to 431      |
| VPHASE | Same for all formats | -100 to 100      |

# 3. Setup

## <Phase adjustment setup>

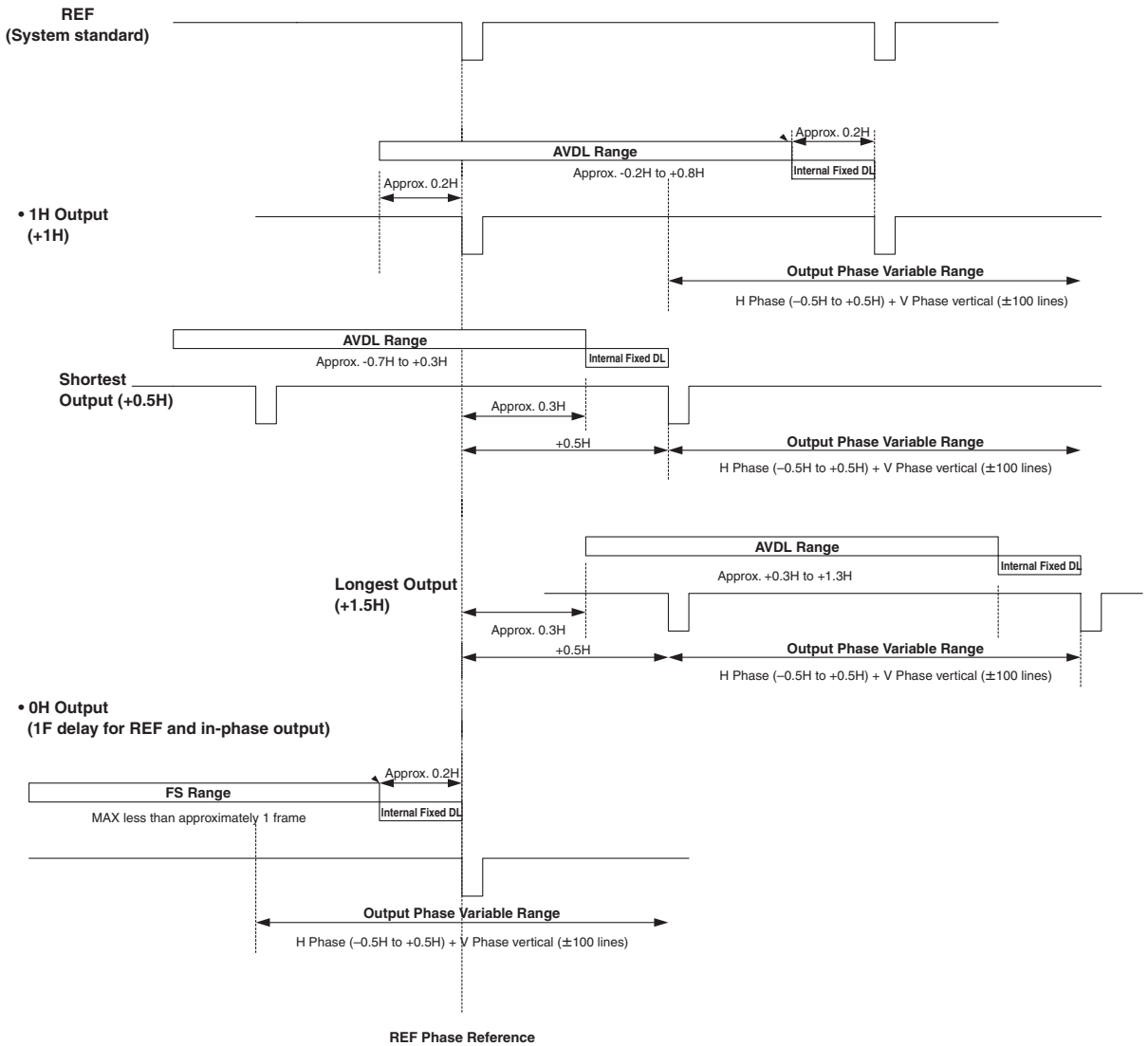

AVDL Range: Range for automatic phase adjustment.

# 3. Setup

---

## 3-7. Network settings

Set up the network for transmitting image files by Ethernet. For details on image transmission method, refer to "5. Image transmission functions".

The network initial setup is: IP address: 192.168.0.10, subnet mask: 255.255.255.0 and gateway: 0.0.0.0 (unused). When using the host computer with settings matching the network setup, it is not necessary to setup via the menu.

For the setting to take effect, the system must be rebooted. Turn the system's power off and then back on.

### ■Setting the IP address

- ① Press the [FUNC] switch to light its indicator, and then press the [SETUP] switch to display the SETUP menu.
- ② Turn [F1] to display the IP menu.
- ③ Turn [F2] to select the setting location. An asterisk (\*) appears at the setting location.
- ④ Turn [F3] to set the number, and press the [F3] switch to enter the setting. If the setting is not entered even though it has been changed, "!" appears above the setting location, and when the setting location is moved by turning [F2], the value prior to the change is restored.

|      |  |          |    |    |
|------|--|----------|----|----|
| IP   |  | !*       |    |    |
| 7/15 |  | 192.168. | 0. | 10 |

### ■Setting the subnet mask

- ① On the SETUP menu, turn [F1] to display the MASK menu.
- ② Turn [F2] to select the setting location. An asterisk (\*) appears at the setting location.
- ③ Turn [F3] to set the number, and press the [F3] switch to enter the setting. If the setting is not entered even though it has been changed, "!" appears above the setting location, and when the setting location is moved by turning [F2], the value prior to the change is restored.

|      |  |              |   |  |
|------|--|--------------|---|--|
| MASK |  | *            |   |  |
| 8/15 |  | 255.255.255. | 0 |  |

# 3. Setup

---

## ■Setting the gateway

- ① On the SETUP menu, turn [F1] to display the GW (Gateway) menu.
- ② Turn [F2] to select the setting location. An asterisk (\*) appears at the setting location.
- ③ Turn [F3] to set the number, and press the [F3] switch to enter the setting. If the setting is not entered even though it has been changed, “!” appears above the setting location, and when the setting location is moved by turning [F2], the value prior to the change is restored.

|      |  |    |    |    |   |  |
|------|--|----|----|----|---|--|
| GW   |  | *  |    |    |   |  |
| 9/15 |  | 0. | 0. | 0. | 0 |  |

## ■Setting the MAC address

- ① On the SETUP menu, turn [F1] to display the MAC menu.  
The MAC address now appears.

(When the MAC address is “008045448000”.)

|       |  |              |  |  |  |  |
|-------|--|--------------|--|--|--|--|
| MAC   |  |              |  |  |  |  |
| 10/15 |  | 008045448000 |  |  |  |  |

# 3. Setup

---

## 3-8. Other settings

### 3-8-1. LCD backlight

The LCD backlight can be set to ON or OFF.

- ① Press the [FUNC] switch to light its indicator, and then press the [SETUP] switch to display the SETUP menu.
- ② Turn [F1] to display the SYS menu.  
Turn [F2], and select ON or OFF for the backlight using the BL item.

|       |     |      |     |
|-------|-----|------|-----|
| SYS   | BL  | VANC | BB  |
| 12/15 | ON  | OFF  | 7.5 |
|       | OFF | ON   | 0   |

### 3-8-2. Setting the ancillary data

Whether the ancillary data which is superimposed on the vertical blanking period of the input images is to be passed through can be selected.

- ① Press the [FUNC] switch to light its indicator, and then press the [SETUP] switch to display the SETUP menu.
- ② Turn [F1] to display the SYS menu.  
Turn [F3], and select ON or OFF for the ancillary data using the VANC item.  
**ON:** The ancillary data is passed through.  
**OFF:** The ancillary data is not passed through.

|       |     |      |     |
|-------|-----|------|-----|
| SYS   | BL  | VANC | BB  |
| 12/15 | ON  | OFF  | 7.5 |
|       | OFF | ON   | 0   |

### 3-8-3. BB signal setup level

The setup level of the BB signal in the internal sync mode can be selected. The level selected takes effect with the 59.94i or 59.94p format. It is fixed at 0 IRE with the 50i or 50p format.

- ① Press the [FUNC] switch to light its indicator, and then press the [SETUP] switch to display the SETUP menu.
- ② Turn [F1] to display the SYS menu.  
Turn [F4], and select the setup level using the BB item.  
**0:** 0 IRE  
**7.5:** 7.5 IRE

|       |     |      |     |
|-------|-----|------|-----|
| SYS   | BL  | VANC | BB  |
| 12/15 | ON  | OFF  | 7.5 |
|       | OFF | ON   | 0   |



# 3. Setup

---

## 3-9. Status displays

The statuses can be displayed.

- ① Press the [FUNC] switch to light its indicator, and then press the [SETUP] switch to display the SETUP menu.
- ② Turn [F1] to display the STATS menu.

**ALM (alarm):** Indicates a fan and/or power supply alarm.

FAN → Fan alarm

POWR → Power supply alarm

F, P → Fan alarm and power supply alarm

NO → No alarm information

**OPT (option):** Indicates whether or not an optional board is provided.

ANLG → The HD analog board has been inserted.

NO → The HD analog board has not been inserted.

**VER (version):** Indicates the software version.

```
STATS | ALM | OPT | VER  
15/15 | FAN | ANLG | 1.00
```

```
POWR | NO  
F, P  
NO
```

## 3-10. Initialization

All the settings except the preset memory can be returned to the factory defaults.

(When they are returned, the images in the frame memory will also be initialized.)

- ① Press the [FUNC] switch to light its indicator, and then press the [SETUP] switch to display the SETUP menu.
- ② Turn [F1] to display the INIT menu.
- ③ Press [F2] to initialize the settings. The "INIT?" message appears.
- ④ To initialize the settings, turn [F2] to select YES, and then press the [F2] switch.  
To cancel the initialization, turn [F2] to select NO, and then press the [F2] switch.

```
INIT | INIT |  
14/15 | EXEC |
```



```
INIT | INIT? |  
14/15 | NO |
```

```
YES
```

## 4. Setting menu table



A setting is entered when an item displayed (  ) is selected and then the [F1], [F2], [F3] or [F4] switch is pressed. (It will not be entered unless the switch is pressed.)

| Menu           | Submenu            |               | Parameter 1   | Parameter 2        | Parameter 3   |
|----------------|--------------------|---------------|---|--------------------|---|
|                | Turn F1 to select. |               | Turn F2 to select.                                      | Turn F3 to select. | Turn F4 to select.                                      |
| TIME           | <b>BKGD</b>        | Parameter     | <b>TRANSTIME</b>  |                    | <b>UNIT</b>   |
|                | 1/2                | Setting range | 0 to 13s  | 0 to 999f          | F<br>SEC  |
|                |                    | Default value | —   | 30f                | SEC   |
|                | <b>KEY</b>         | Parameter     | <b>TRANSTIME</b>  |                    | <b>UNIT</b>   |
|                | 2/2                | Setting range | 0 to 13s  | 0 to 999f          | F<br>SEC  |
|                |                    | Default value | —   | 30f                | SEC   |
| WIPE           | <b>BODR</b>        | Parameter     | <b>WIDT</b>   | <b>SOFT</b>        | <b>COLR</b>   |
|                | 1/5                | Setting range | 0 to 255  | 0 to 255           | WHT, YLW, CYN<br>GRN, MGT, RED<br>BLE, BLK<br>USR1 to 4 |
|                |                    | Default value | 0   | 0                  | WHT   |
|                | <b>USR1(*)</b>     | Parameter     | <b>HUE</b>  | <b>SAT</b>         | <b>LUM</b>  |
|                | 2/5                | Setting range | 0 to 359  | 0 to 100           | 0 to 108  |
|                |                    | Default value | 0   | 0                  | 100   |
|                | <b>USR2(*)</b>     | Parameter     | <b>HUE</b>  | <b>SAT</b>         | <b>LUM</b>  |
|                | 3/5                | Setting range | 0 to 359  | 0 to 100           | 0 to 108  |
|                |                    | Default value | 355   | 100                | 7   |
|                | <b>USR3(*)</b>     | Parameter     | <b>HUE</b>  | <b>SAT</b>         | <b>LUM</b>  |
|                | 4/5                | Setting range | 0 to 359  | 0 to 100           | 0 to 108  |
|                |                    | Default value | 50  | 100                | 29  |
| <b>USR4(*)</b> | Parameter          | <b>HUE</b>    | <b>SAT</b>  | <b>LUM</b>         |   |
| 5/5            | Setting range      | 0 to 359      | 0 to 100  | 0 to 108           |   |
|                | Default value      | 0             | 0   | 0                  |   |
| CBGD           | <b>CBGD</b>        | Parameter     | <b>COLR</b>   | —                  | —   |
|                | 1/5                | Setting range | WHT, YLW, CYN<br>GRN, MGT, RED<br>BLE, BLK<br>USR1 to 4 | —                  | —   |
|                |                    | Default value | WHT   |                    |   |
|                | <b>USR1(*)</b>     | Parameter     | <b>HUE</b>  | <b>SAT</b>         | <b>LUM</b>  |
|                | 2/5                | Setting range | 0 to 359  | 0 to 100           | 0 to 108  |
|                |                    | Default value | 0   | 0                  | 100   |
|                | <b>USR2(*)</b>     | Parameter     | <b>HUE</b>  | <b>SAT</b>         | <b>LUM</b>  |
|                | 3/5                | Setting range | 0 to 359  | 0 to 100           | 0 to 108  |
|                |                    | Default value | 355   | 100                | 7   |
|                | <b>USR3(*)</b>     | Parameter     | <b>HUE</b>  | <b>SAT</b>         | <b>LUM</b>  |
| 4/5            | Setting range      | 0 to 359      | 0 to 100  | 0 to 108           |   |
|                | Default value      | 50            | 100   | 29                 |   |



## 4. Setting menu table

| Menu           | Submenu                           |               | Parameter 1                         | Parameter 2   | Parameter 3   |
|----------------|-----------------------------------|---------------|-------------------------------------|---|---|
|                | Turn F1 to select.                |               | Turn F2 to select.                  | Turn F3 to select.                                      | Turn F4 to select.                                      |
| CBGD           | <b>USR4(*)</b>                    | Parameter     | <b>HUE</b>                          | <b>SAT</b>  | <b>LUM</b>  |
|                | 5/5                               | Setting range | 0 to 359                            | 0 to 100  | 0 to 108  |
|                |                                   | Default value | 0                                   | 0   | 0   |
| KEY            | <b>KEY</b>                        | Parameter     | <b>TYPE</b>                         | <b>INV</b>  | <b>PVW</b>  |
|                | 1/7                               | Setting range | SELF<br>LIN                         | ON<br>OFF   | ON<br>OFF<br>AUTO                                       |
|                |                                   | Default value | LIN                                 | OFF   | AUTO  |
|                | <b>K-ADJ</b>                      | Parameter     | <b>CLIP</b>                         | <b>GAIN</b>   | <b>DENS</b>   |
|                | 2/7                               | Setting range | 0 to 108                            | 0 to 200  | 0 to 100  |
|                |                                   | Default value | 0                                   | 100   | 100   |
|                | <b>FILL</b>                       | Parameter     | <b>TYPE</b>                         | <b>COLR</b>   |   |
|                | 3/7<br>◇KEY-F Link<br>from switch | Setting range | BUS<br>COLR                         | WHT, YLW, CYN<br>GRN, MGT, RED<br>BLE, BLK<br>USR1 to 4 |   |
|                |                                   | Default value | BUS                                 | BLE   |   |
|                | <b>USR1(*)</b>                    | Parameter     | <b>HUE</b>                          | <b>SAT</b>  | <b>LUM</b>  |
|                | 4/7                               | Setting range | 0 to 359                            | 0 to 100  | 0 to 108  |
|                |                                   | Default value | 0                                   | 0   | 100   |
|                | <b>USR2(*)</b>                    | Parameter     | <b>HUE</b>                          | <b>SAT</b>  | <b>LUM</b>  |
|                | 5/7                               | Setting range | 0 to 359                            | 0 to 100  | 0 to 108  |
|                |                                   | Default value | 355                                 | 100   | 7   |
| <b>USR3(*)</b> | Parameter                         | <b>HUE</b>    | <b>SAT</b>                          | <b>LUM</b>  |   |
| 6/7            | Setting range                     | 0 to 359      | 0 to 100                            | 0 to 108  |   |
|                | Default value                     | 50            | 100                                 | 29  |   |
| <b>USR4(*)</b> | Parameter                         | <b>HUE</b>    | <b>SAT</b>                          | <b>LUM</b>  |   |
| 7/7            | Setting range                     | 0 to 359      | 0 to 100                            | 0 to 108  |   |
|                | Default value                     | 0             | 0                                   | 0   |   |
| EDGE           | <b>EDGE</b>                       | Parameter     | <b>TYPE</b>                         | <b>WIDT</b>   | <b>COLR</b>   |
|                | 1/5                               | Setting range | OFF<br>BODR<br>DROP<br>SHDW<br>OUTL | 0 to 4  | WHT, YLW, CYN<br>GRN, MGT, RED<br>BLE, BLK<br>USR1 to 4 |
|                |                                   | Default value | OFF                                 | 2   | YLW   |
|                | <b>USR1(*)</b>                    | Parameter     | <b>HUE</b>                          | <b>SAT</b>  | <b>LUM</b>  |
|                | 2/5                               | Setting range | 0 to 359                            | 0 to 100  | 0 to 108  |
|                |                                   | Default value | 0                                   | 0   | 100   |
| <b>USR2(*)</b> | Parameter                         | <b>HUE</b>    | <b>SAT</b>                          | <b>LUM</b>  |   |
| 3/5            | Setting range                     | 0 to 359      | 0 to 100                            | 0 to 108  |   |
|                | Default value                     | 355           | 100                                 | 7   |   |

## 4. Setting menu table

| Menu         | Submenu            |                 | Parameter 1                              | Parameter 2                               | Parameter 3   |
|--------------|--------------------|-----------------|--|---|---|
|              | Turn F1 to select. |                 | Turn F2 to select.                       | Turn F3 to select.                        | Turn F4 to select.  |
| EDGE         | <b>USR3(*)</b>     | Parameter       | <b>HUE</b>                               | <b>SAT</b>                                | <b>LUM</b>  |
|              | 4/5                | Setting range   | 0 to 359                                 | 0 to 100                                  | 0 to 108  |
|              |                    | Default value   | 50                                       | 100                                       | 29  |
|              | <b>USR4(*)</b>     | Parameter       | <b>HUE</b>                               | <b>SAT</b>                                | <b>LUM</b>  |
|              | 5/5                | Setting range   | 0 to 359                                 | 0 to 100                                  | 0 to 108  |
|              |                    | Default value   | 0  | 0   | 0   |
| MEM          | <b>PSMEM</b>       | Parameter       | <b>MODE</b>                              | <b>NO.</b>                                |   |
|              | 1/3                | Setting range   | STOR<br>RECL<br>CLR                      | *1 to 10                                  | EXEC (  )                              |
|              |                    | Default value   | STOR                                     | 1   | —   |
|              | <b>PSMEM</b>       | Parameter       | <b>XPT</b>                               | —   | —   |
|              | 2/3                | Setting range   | DSBL<br>ENBL                             | —   | —   |
|              |                    | Default value   | DSBL                                     | —   | —   |
|              | <b>FMEM</b>        | Parameter       | <b>SIG</b>                               | <b>MEM</b>                                | <b>STOR</b>   |
|              | 3/3                | Setting range   | AUX                                      | FMEM                                      | EXEC (  )                              |
|              | Default value      | —               | —  | —   |   |
| XPT          | <b>XPTAS</b>       | Display only    | SIG: B 1 2 3 4 5 D<br>XPT: 1 2 3 4 5 6 7 |   |   |
|              | 1/3                |                 |  |   |   |
|              | <b>XPTAS</b>       | Parameter       | <b>XPT</b>                               | <b>SIG</b>                                | —   |
|              | 2/3                | Setting range   | 1 to 7                                   | IN1 to 5, DVI<br>BLK, CBGD,<br>CBAR, FMEM | —   |
|              |                    | Default value   | 1  | BLK                                       | —   |
|              |                    |                 | 2  | IN1                                       | —   |
|              |                    |                 | 3  | IN2                                       | —   |
|              |                    |                 | 4  | IN3                                       | —   |
|              |                    |                 | 5  | IN4                                       | —   |
|              |                    |                 | 6  | IN5                                       | —   |
|              |                    |                 | 7  | DVI                                       | —   |
| <b>XPTSW</b> | Parameter          | <b>TIMG</b>     | —  | —   |   |
| 3/3          | Setting range      | ANY<br>F1<br>F2 | —  | —   |   |
|              | Default value      | ANY             | —  | —   |   |
| FRZ          | <b>FRZ</b>         | Display only    | FRZ: * * * * *<br>XPT: 1 2 3 4 5 6 7     |   |   |
|              | 1/2                |                 |  |   |   |
|              | <b>FRZ</b>         | Parameter       | <b>SIG</b>                               | —   | <b>FRZ</b>  |
|              | 2/2                | Setting range   | IN1 to 5, DVI                            | —   | Toggleing between<br>ON and OFF (  ) |
|              |                    | Default value   | IN1 to 5, DVI                            | —   | OFF   |

## 4. Setting menu table

| Menu       | Submenu            |                      | Parameter 1   | Parameter 2        | Parameter 3  |
|------------|--------------------|----------------------|---|--------------------|--|
|            | Turn F1 to select. |                      | Turn F2 to select.  | Turn F3 to select. | Turn F4 to select.   |
| SETUP      | <b>IN1-5</b>       | Parameter            | <b>SIG</b>  | <b>MODE</b>        | <b>GAIN</b>  |
|            | 1/15               | Setting range        | IN1 to 5  | SDI<br>ANLG        | -30 to 30  |
|            |                    | Default value        | IN1 to 5  | SDI<br>ANLG        | —<br>0   |
|            | <b>DVIIN</b>       | Parameter            | <b>MODE</b>   | <b>SCAL</b>        | —  |
|            | 2/15               | Setting range        | DIG<br>ANLG   | NORM<br>FULL       | —  |
|            |                    | Default value        | DIG   | NORM               | —  |
|            | <b>FS</b>          | Parameter            | <b>SIG</b>  | <b>FS</b>          | —  |
|            | 3/15               | Setting range        | IN1 to 5  | ON<br>OFF          | —  |
|            |                    | Default value        | IN1 to 5  | ON                 | —  |
|            | <b>FORMT</b>       | Parameter            | <b>MODE</b>   | —                  | —  |
|            | 4/15               | Setting range        | *1080/59i<br>1080/50i<br>720/59p<br>720/50p<br>480/59i<br>576/50i | —                  | EXEC (  )   |
|            |                    | Default value        | 1080/59i  | —                  | —  |
|            | <b>REF</b>         | Parameter            | <b>SYNC</b>   | <b>GL</b>          | —  |
|            | 5/15               | Setting range        | *BBST<br><br>BBAD<br>TRI<br>INT                                   | *<br>—             | EXEC (  ) |
|            |                    | Default value        | BBST  | —                  | —  |
|            | <b>OUPHS</b>       | Parameter            | <b>SYS</b>  | <b>HPHS</b>        | <b>VPHS</b>  |
|            | 6/15               | Setting range        | 0H<br>1H  | -1320 to 1319      | -100 to 100  |
|            |                    | Default value        | 1H  | 0                  | 0  |
|            | <b>IP</b>          | Setting range        | Cursor movement   | 0 to 255           |  |
|            | 7/15               | Default value        | 192.168.0.10  |                    |  |
|            | <b>MASK</b>        | Setting range        | Cursor movement   | 0 to 255           |  |
|            | 8/15               | Default value        | 255.255.255.0   |                    |  |
|            | <b>GW</b>          | Setting range        | Cursor movement   | 0 to 255           |  |
|            | 9/15               | Default value        | 0.0.0.0   |                    |  |
|            | <b>MAC</b>         | Display only         | 12-digit address display  |                    |  |
|            | 10/15              | Default value        | —   |                    |  |
| <b>BUS</b> | Parameter          | <b>MODE</b>          | —   | —                  |  |
| 11/15      | Setting range      | A/B<br>P/P (PGM/PST) | —   | —                  |  |
|            | Default value      | P/P                  | —   | —                  |  |

## 4. Setting menu table

| Menu  | Submenu            |               | Parameter 1  | Parameter 2        | Parameter 3        |
|-------|--------------------|---------------|--|--------------------|--------------------|
|       | Turn F1 to select. |               | Turn F2 to select.   | Turn F3 to select. | Turn F4 to select. |
| SETUP | <b>SYS</b>         | Parameter     | <b>BL</b>  | <b>VANC</b>        | <b>BB</b>          |
|       | 12/15              | Setting range | ON<br>OFF  | ON<br>OFF          | 0<br>7.5           |
|       |                    | Default value | ON   | OFF                | 7.5                |
|       | <b>DVIPH</b>       | Parameter     | <b>CKPH</b>  | <b>HPOS</b>        | <b>VPOS</b>        |
|       | 13/15              | Setting range | -16 to 15  | -100 to 100        | -100 to 100        |
|       |                    | Default value | 0  | 0                  | 0                  |
|       | <b>INIT</b>        | Parameter     | <b>INIT</b>  | —                  | —                  |
|       | 14/15              | Setting range | EXEC (  ) |                    |                    |
|       | <b>STATS</b>       | Parameter     | <b>ALM</b>   | <b>OPT</b>         | <b>VER</b>         |
|       | 15/15              | Display only  | FAN<br>POWR<br>F, P<br>NO  | ANLG<br>NO         | Version number     |

\* The same USR1 to USR4 parameters are used for the WIPE menu, CBGD menu, KEY menu and EDGE menu.

# 5. Image transmission functions

This unit comes with a function for transmitting still images from the host computer to the unit via Ethernet and a function for importing still images from the unit into the host computer. The image transmission program must be installed in the host computer from the CD-ROM supplied in order to use these functions. For details on installation, refer to “How to install the program”.

## ■Specifications

Run the image transmission program (HS300 Tool) in a host computer which satisfies the following conditions.

- Operating system: Windows 2000 or Windows XP
- Processor: Pentium III, 1 GHz or better recommended
- RAM: 256 MB or more recommended
- Hard disk drive: At least 50 MB of free memory
- Ethernet: 10BASE-T or 100BASE-TX
- Display: TrueColor (24 bit, 32 bit color), 800 × 600 dots or more

The image formats supported include bitmap (bmp), JPEG (jpg), TIFF (tif), GIF (gif) and PNG (png). The image transmission program is equipped with a function for automatically converting images into the specified video format size.

## ■Connections

Connect this unit to Ethernet using a twisted pair cable. Use a LAN crossover cable to connect the unit with the host computer directly. Use a LAN straight cable to connect to Ethernet using a hub or other equipment. For details on network setup such as IP addresses, refer to [3-7 Network settings]. Transmitting images uses network capacity which may result in other connected devices possibly being affected when connecting to Ethernet through a hub and other equipment.

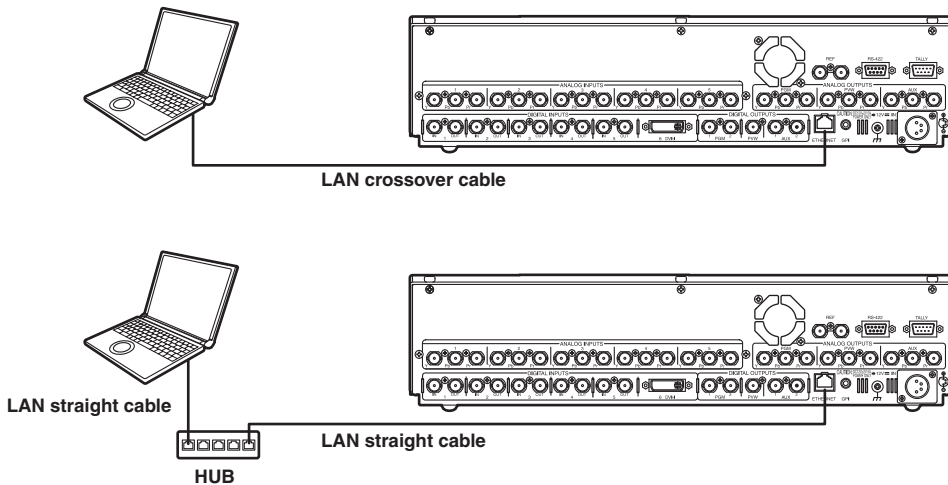

# 5. Image transmission functions

## ■How to install the program

This section describes how to install the image transmission program (HS300 Tool). Windows XP is used as the host computer's operating system in the example given here.

1. Insert the CD-ROM supplied with the unit into the CD-ROM drive of the host computer in which the program will be installed. (Here, E: will serve as the name of this drive for example.)
2. Execute the setup program (E:\HS300TOOL\ENG\SETUP.EXE).
3. The installer now starts up so follow its instructions to proceed.



4. The Setup Complete screen appears to indicate that installation is complete. Click [Finish] to close the window.





# 5. Image transmission functions

---

## ■Operation

This section describes how to operate the image transmission program (HS300 Tool).

### <Startup>

On the Start menu of Windows, select [Programs] → [Panasonic] → [AV-HS300Tool] → [HS300Tool].  
The main screen now appears.



### <Exit>

Click the [CLOSE] button.

### <Setting the IP address>

Set the unit's IP address in the IP Address setting box.

# 5. Image transmission functions

## <Transmitting images to the unit>

1. Select the mode.  
Check that "To HS300" appears in the [Mode] field.  
If "From HS300" appears instead, click the Mode button so that "To HS300" appears.
2. When the [Select Image] button is clicked, the file selection dialog box appears on the screen.  
Select the image file to be transmitted, and click [OK].  
The image is now displayed in the image display area, and its horizontal and vertical dimensions appear in the [Width] and [Height] fields at the bottom right.
3. In the [Size] field, select the size of the image to be transmitted to the unit.  
HD1080 (1920 × 1080), HD720 (1280 × 720), SD NTSC (720 × 488) or SD PAL (720 × 576) can be selected as the size. If the image is in a different video format from the ones supported by the unit, the output will not be displayed properly.
4. In the [Aspect] field, select the scaling method.  
If the size of the image to be transmitted and the selected image differ, the image will be automatically scaled according to one of the following methods.
  - Full:** The size of the image is increased or reduced so that it fits the size selected in the [Size] field. If the aspect ratio of the image to be transmitted differs from that of the selected image, the ratio between the horizontal and vertical dimensions will be changed.
  - Keep:** The image is expanded or reduced while its original aspect ratio is kept unchanged.  
Any empty spaces in the image will appear black.
5. Click the [Send] button to transmit the image to the unit.

## <Transmitting images from the unit>

1. Select the mode.  
Check that "From HS300" appears in the [Mode] field.  
If "To HS300" appears instead, click the Mode button so that "From HS300" appears.

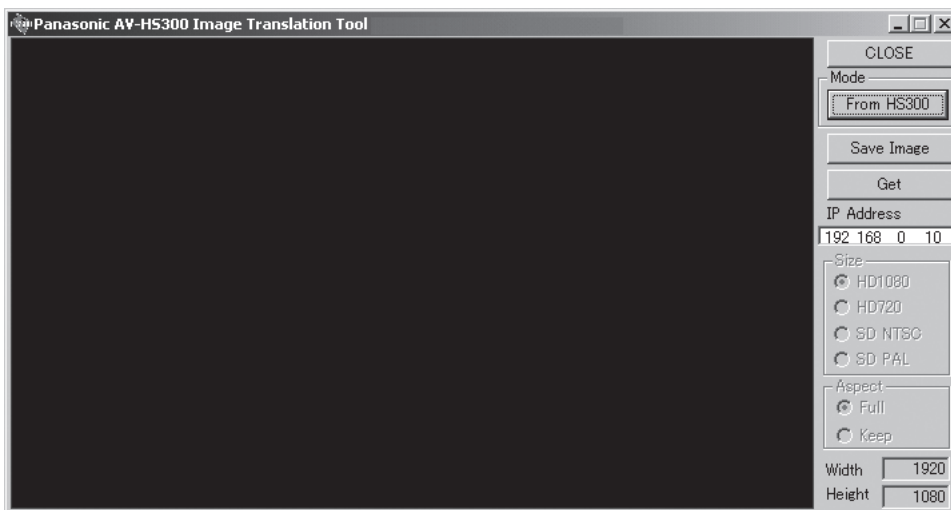

2. When the [Get] button is clicked, the image is imported from the unit.  
The image is now displayed in the image display area, and its horizontal and vertical dimensions appear in the Width and Height fields at the bottom right.
3. When the [Save Image] button is clicked, the file save dialog box appears on the screen. Select the image file to be transmitted, and click [Save].

# 6. External interfaces

This unit comes with RS-422, GPI and tally connectors to serve as external interfaces.

## 6-1. RS-422 connector

This enables the unit to be controlled by an editing controller AG-A850. Use it with the settings below.

- Baud rate:** 38400 bps
- Parity:** ODD
- Stop bit:** 1 bit

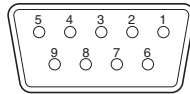

### Pin assignment

| Pin No. | Signal name  | Description of signal |
|---------|--------------|-----------------------|
| 1       | FRAME GROUND | Frame ground          |
| 2       | TXD –        | Send data (–)         |
| 3       | RXD +        | Receive data (+)      |
| 4       | GROUND       | Ground                |
| 5       | NC           | Not used              |
| 6       | GROUND       | Ground                |
| 7       | TXD +        | Send data (+)         |
| 8       | RXD –        | Receive data (–)      |
| 9       | FRAME GROUND | Frame ground          |

The following lists the functions which can be controlled by AG-A850. (Compliant with the GVG protocol)

- Crosspoint switch
- Wipe pattern selection
- Transition mode (MIX/WIPE) selection
- Auto transition time setting
- Auto transition execution

If the [AUX] switch is pressed twice, the lamp of the switch will light up red.

While the lamp is lighted up red, control exercised from an external source can be canceled.

If the same switch is pressed twice again while its lamp is still lighted up red, the lamp is extinguished, and the control exercised from an external source is re-established.

## 6-2. GPI connector

This enables auto take operations to be executed by an external device.

Auto transitions are executed at the fall of the GPI signals.

The signals are input using contacts. The auto take operations are executed using these contacts as triggers.

Use an M3.5 stereo plug for connection with the main unit.

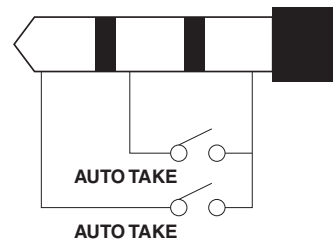

# 6. External interfaces

## 6-3. Tally connector

The tally connector comes with tally output, output enable, power supply or fan alarm output pins. The output signals from the tally output pins are for lighting the tally lamps, and these outputs are open collector outputs.

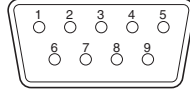

### Pin assignment

| Pin No. | Signal name | Input/output          | Description of signal   |
|---------|-------------|-----------------------|---|
| 1       | IN1         | Open collector output | Tally output of input video 1                                 |
| 2       | IN2         | Open collector output | Tally output of input video 2                                 |
| 3       | IN3         | Open collector output | Tally output of input video 3                                 |
| 4       | IN4         | Open collector output | Tally output of input video 4                                 |
| 5       | IN5         | Open collector output | Tally output of input video 5                                 |
| 6       | IN6         | Open collector output | Tally output of input video 6                                 |
| 7       | ENABLE      | Input                 | Enable signal of tally output<br>Open: Output; GND: no output |
| 8       | ALARM       | Open collector output | Fan alarm or power supply alarm output                        |
| 9       | GROUND      | GROUND                | Ground  |

Pins 1 to 6 and pin 8 must satisfy the following conditions:

Dielectric strength: Max. DC 24 V

Current: Max. 50 mA

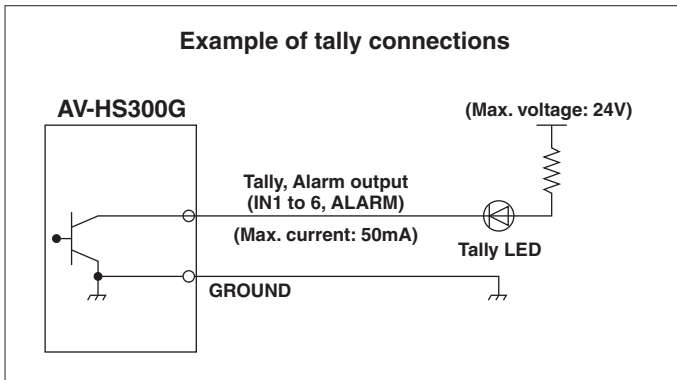

# 7. Connections

## ■ Connections when implementing gen-lock (frame synchronizer OFF)

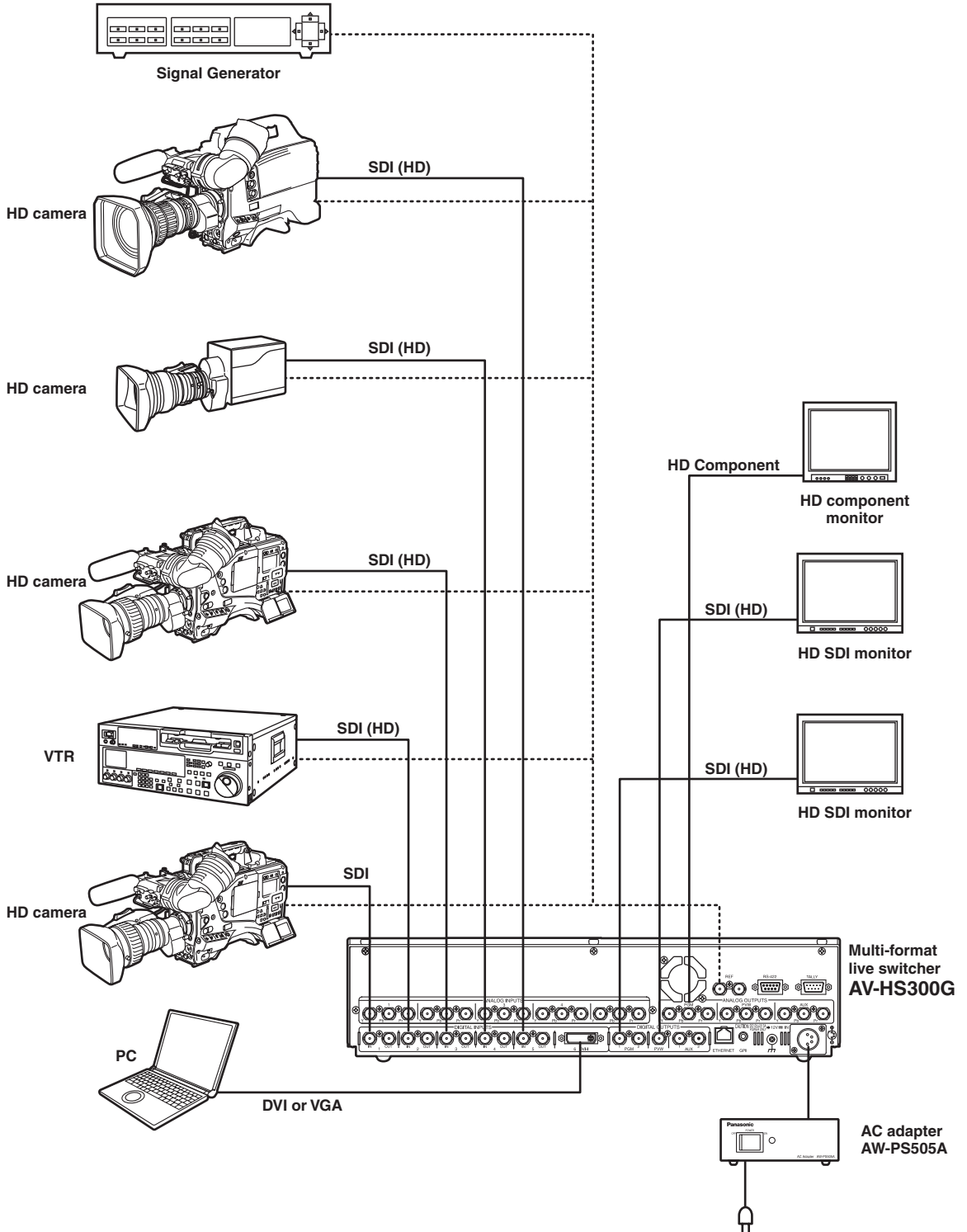

# 7. Connections

## ■ Connections when not implementing gen-lock (frame synchronizer ON)

- Example where the optional HD analog board is used

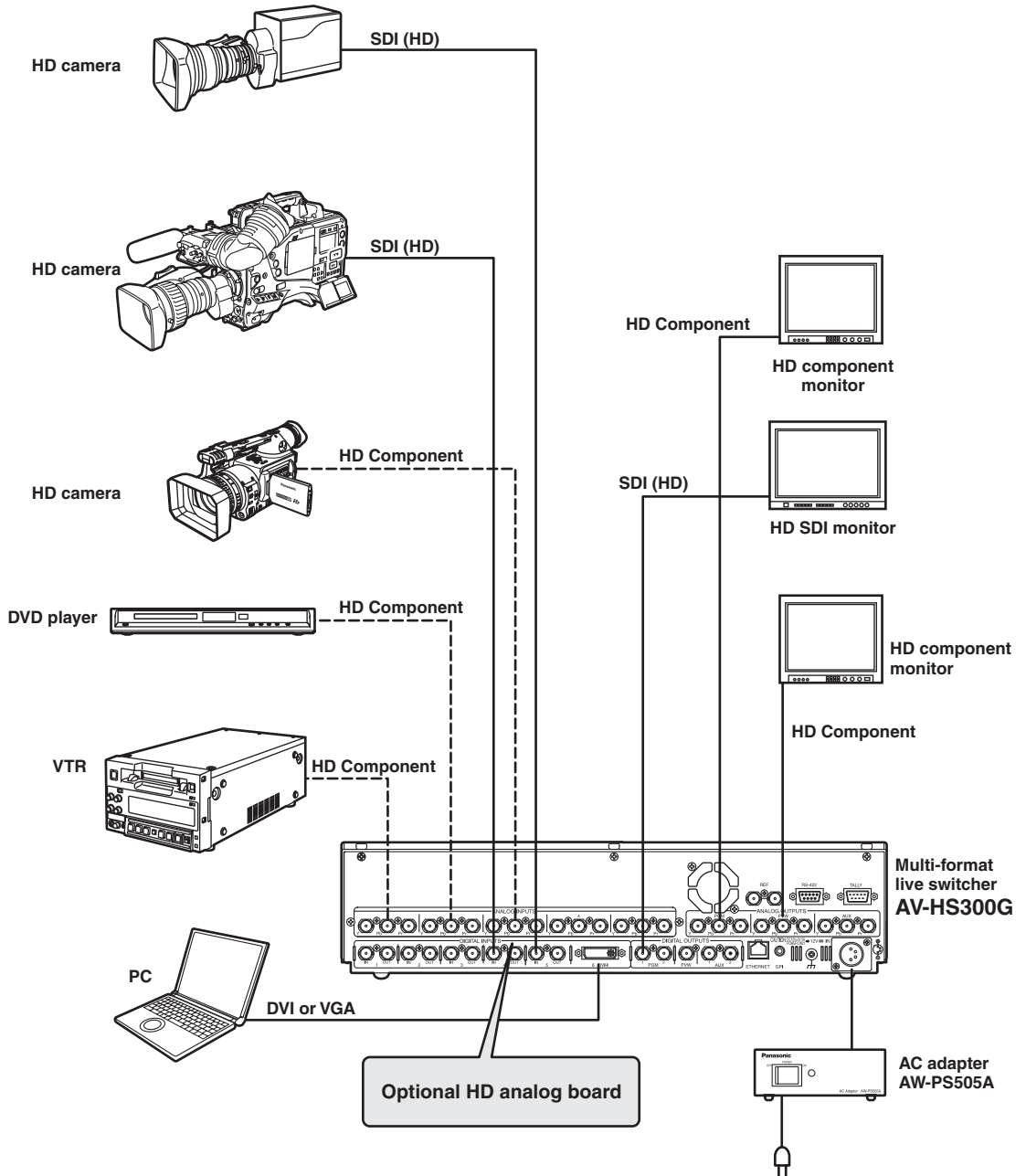

# 8. Appearance

Unit: inch (mm)

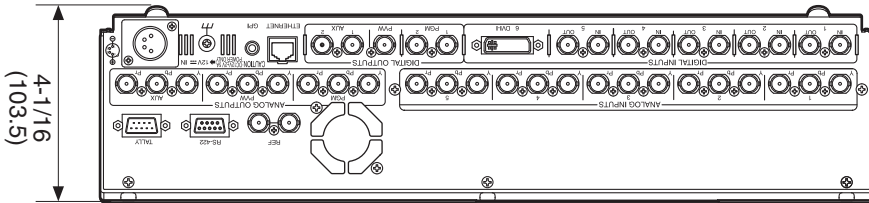

4-1/16  
(103.5)

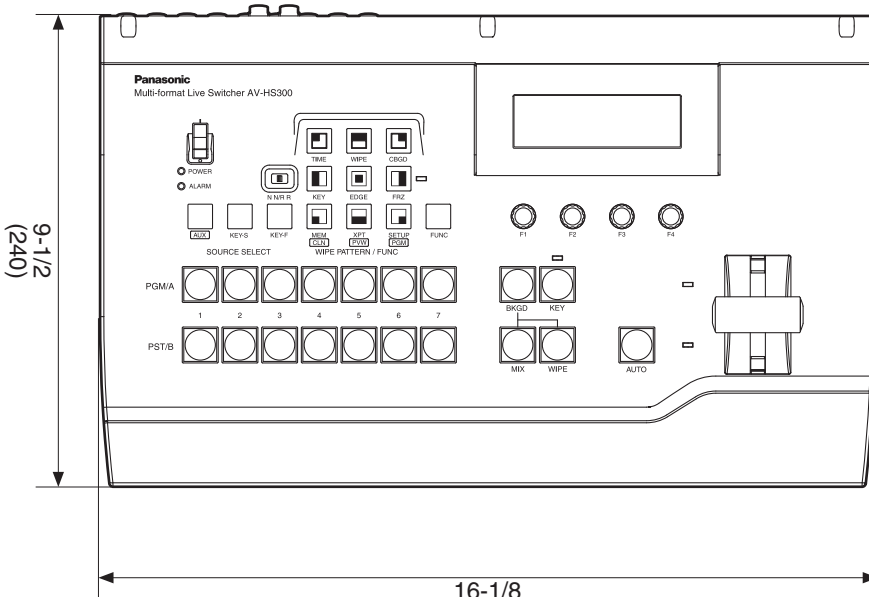

9-1/2  
(240)

16-1/8  
(410)

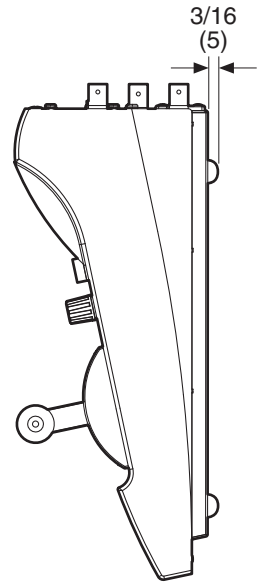

3/16  
(5)

# Specifications and standard accessories

## ■ Specifications

|                          |   |
|--------------------------|---|
| <b>Inputs</b>            | Video inputs × 6 (SDI × 5, DVI-I × 1, analog HD × 5 [optional])<br>Reference × 1  |
| <b>Outputs</b>           | Video outputs × 3 (PGM, PVW, AUX)<br>PGM: SDI × 2 outputs, analog HD × 1 output<br>PVW: SDI × 1 output, analog HD × 1 output<br>AUX: SDI × 2 outputs, analog HD × 1 output<br>Reference × 1   |
| <b>Signal formats</b>    | SD: 480/59.94i, 576/50i<br>HD: 1080/59.94i, 1080/50i, 720/59.94p, 720/50p   |
| <b>Signal processing</b> | Y:Cb:Cr 4: 2: 2, 10 bit<br>RGB 4:4:4, 8 bit   |
| <b>ME number</b>         | 1ME   |
| <b>SDI inputs</b>        | HD: Serial digital (SMPTE 292M)<br>SD: Component digital (SMPTE 259M)   |
|                          | IN1 to 5 (with active through)  |
|                          | HD [SMPTE 292M (BTA S-004B) standard complied with]<br>• 0.8 Vp-p ±10 % (75 Ω)<br>• Input return loss      More than 15 dB (5 MHz to 750 MHz)<br>More than 10 dB (750 MHz to 1.5 GHz)<br>• Automatic equalizer    More than 100 m (5C-FB)   |
|                          | SD [SMPTE 259M standard complied with]<br>• 0.8 Vp-p ±10 % (75 Ω)<br>• Input return loss      More than 15 dB (5 MHz to 270 MHz)<br>• Automatic equalizer    200 m (5C-2V)  |
| <b>SDI outputs</b>       | HD: Serial digital (SMPTE 292M)<br>SD: Component digital (SMPTE 259M)   |
|                          | PGM, PVW, AUX   |
|                          | HD [SMPTE 292M (BTA S-004B) standard complied with]<br>• Output return loss    More than 15 dB (5 MHz to 750 MHz)<br>More than 10 dB (750 MHz to 1.5 GHz)<br>• Output level            0.8 Vp-p ±10 %<br>• Rise time                Less than 270 ps<br>• Fall time                 Less than 270 ps<br>• Difference between rise time and fall time<br>Within 100 ps<br>• Alignment jitter        Less than 0.2 UI (130 ps)<br>• Timing jitter             Less than 1.0 UI<br>• Eye aperture ratio      More than 90 %<br>• DC offset                0 ±0.5 V |



# Specifications and standard accessories

|                                      |  |   |
|--------------------------------------|--|---|
| <b>SDI outputs</b>                   | SD [SMPTE 259M standard complied with]   |   |
|                                      | • Output return loss   | More than 15 dB (5 MHz to 270 MHz)  |
|                                      | • Output level   | 0.8 Vp-p ±10 %  |
|                                      | • Rise time  | Less than 1.5 ns  |
|                                      | • Fall time  | Less than 1.5 ns  |
|                                      | • Difference between rise time and fall time   | Less than 0.5 ns  |
|                                      | • Jitter   | Less than 0.2 UI  |
| <b>Analog HD input (option)</b>      | HD analog component Y/Pb/Pr (1.0 Vp-p, 75 Ω)   |   |
|                                      | IN1 to 5   |   |
| <b>Analog HD output</b>              | HD analog component Y/Pb/Pr (1.0 Vp-p, 75 Ω)   |   |
|                                      | PGM, PVW, AUX  |   |
| <b>DVI-I input</b>                   | SXGA 1280 × 1024, XGA 1024 × 768 (60 Hz)   |   |
| <b>Key input</b>                     | 1 input from video inputs  |   |
| <b>Reference input</b>               | Black burst or Tri-level Sync (with loop-through) × 1                                |   |
| <b>Reference output</b>              | In gen-lock mode: loop-through output × 1,<br>In internal sync mode: black burst × 2 |   |
| <b>Video delay time</b>              | Frame synchronizer OFF   | 1H  |
|                                      | Frame synchronizer ON  | 1F  |
| <b>Control I/O</b>                   | Ethernet   | 100 Mbps/10 Mbps × 1<br>Image transmission function available<br>(provided with transmission program) |
|                                      | Serial communication interface   | RS-422A (D-SUB 9-pin) × 1   |
|                                      | Tally output   | Open collector outputs (negative logic) 1 to 6  |
|                                      | GPI  | Auto take × 1   |
| <b>Ambient operating temperature</b> | 32 °F to 104 °F (0 °C to 40 °C)  |   |
| <b>Humidity</b>                      | 10 % to 90 % (no condensation)   |   |
| <b>Power supply</b>                  | DC 12 V ±2 V   |   |
|                                      | Power consumption  | 46.8 W  |
| <b>Dimensions (W × H × D)</b>        | 16-1/8" × 4-1/16" × 9-1/2" (410 × 103.5 × 240 mm)<br>[Excluding protrusions]         |   |
| <b>Weight</b>                        | 7.1 lbs. (3.2 kg)  |   |

## ■ Standard accessories

|  |   |
|--|---|
| Operating instructions .....                                   | 1 |
| Operation manual / Image transmission program install CD ..... | 1 |

## ■ Optional accessories

HD analog board AV-HSB300  
Refer to the operating instructions that come with the HD analog board for details about the installation method.

# Appendix (glossary)

Defined below are the terms used in this manual.

| Word   | Explanation   |
|--|---|
| <b>AB Bus system</b>                         | A bus control mode. By executing a transition, the A bus and B bus signals are output to the program images alternately.  |
| <b>Ancillary Data</b>                        | The auxiliary data other than the video signals which is transmitted inside the data stream of the video serial interface. The data superimposed on the vertical blanking period is referred to as the V ancillary data (VANC). |
| <b>Aspect ratio</b>                          | The ratio between the horizontal and vertical dimensions of an image or screen. It is 16:9 for the HD format and 4:3 for the SD format.   |
| <b>AUX<br/>[Auxiliary Bus]</b>               | A spare bus which can be switched by signals other than the main line output signals.   |
| <b>AVDL<br/>[Automatic Video Delayline]</b>  | A function to automatically adjust the input image signal phase to the horizontal synchronization reference signal phase.   |
| <b>BB<br/>[Black burst]</b>                  | The black burst signal. A full-screen black level composite signal which is used as the reference signal for gen-lock.  |
| <b>Border</b>                                | The area or margin that is added to the edge of a wipe or key. Its width and color can be adjusted. The defocusing of the area around a border is referred to as the soft effect.   |
| <b>Clip</b>                                  | The threshold level of the luminance when key signals are created from a key source.  |
| <b>Color Background</b>                      | The signals which are output from the internal color generator and used as the background image.  |
| <b>Density</b>                               | A parameter which is used to adjust the density of the key signals.   |
| <b>DVI<br/>[Digital Visual Interface]</b>    | A digital video interface standard.<br>DVI-I can handle both digital signals and analog signals.  |
| <b>Ethernet</b>                              | A computer network standard; the 10BASE-T (10 Mbps), 100BASE-TX (100 Mbps) or other such standard based on the transmission speed.  |
| <b>Flip Flop system<br/>(PGM/PST system)</b> | A bus control mode. The signals selected by the program bus are always output as the program images. By executing a transition, the program bus and preset bus signals are switched over.                                       |
| <b>Frame Memory</b>                          | A memory which can hold the video signals equivalent to one frame.  |
| <b>Frame Synchronizer</b>                    | A function which enables the asynchronous video signal input to be switched.  |
| <b>Freeze</b>                                | A function which continues the display of the same image, creating the impression that the image has been "frozen".   |
| <b>Gain</b>                                  | A parameter which adjusts the defocusing of the edges of the key signals.   |

## ***Appendix (glossary)***

---

| <b>Word</b>                                      | <b>Explanation</b>  |
|--|---|
| <b>Genlock</b>                                   | A function for synchronizing the video signals using an external sync signal as the reference.  |
| <b>GPI</b><br><b>[General Purpose Interface]</b> | Interface signals which control auto transition from an external source.  |
| <b>IRE</b>                                       | A unit used for video signal levels.<br>The setup level (black level) of the signals is expressed as 0 IRE, 7.5 IRE, etc.   |
| <b>Hue</b>                                       | The color tone of the video signals.  |
| <b>Key Edge</b>                                  | The border or shadow added to the edges of keys.  |
| <b>Key Fill</b>                                  | The signal that uses key combination processing to fill in the areas left blank by the key signals.   |
| <b>Key invert</b>                                | A function which inverts the key signals.   |
| <b>Key Source</b>                                | The video signals for creating the key signals.   |
| <b>Linear Key</b>                                | The function which combines keys using monochrome key signals with gradations in its outlines as a reference.   |
| <b>Lum</b><br><b>[Luminance]</b>                 | The brightness portion of the video signals.  |
| <b>Luminance Key</b>                             | The function which creates key signals based on the luminance (brightness) information of the video signals to combine keys.  |
| <b>ME</b><br><b>[Mix Effect]</b>                 | A video effect device which combines a number of video signals to create mix, wipe, key and other video signals.  |
| <b>Mix</b>                                       | The picture-changing effect produced by overlapping one image with the next. It is also referred to as "dissolve".  |
| <b>PVW</b><br><b>[Preview]</b>                   | The function for checking ahead of time the image which will be output after the next transition. The image is output from the PVW system.  |
| <b>PGM</b><br><b>[Program Bus]</b>               | The bus which always carries the program output signals.  |
| <b>PST</b><br><b>[Preset Bus]</b>                | The bus which carries the program output signals after the next background transition.  |
| <b>Preset Memory</b>                             | The memory in which the control panel statuses can be saved and recalled. The switch selection statuses as well as the border, color and other setting information can be saved in this memory. |
| <b>RS-422</b>                                    | A serial interface standard. It is the interface used to control the switcher from an editor or other external device.  |
| <b>Sat</b><br><b>[Saturation]</b>                | This refers to the intensity of the color chrominance level of video signals.   |

## ***Appendix (glossary)***

---

| <b>Word</b>                                     | <b>Explanation</b>   |
|---|--|
| <b>SDI</b><br><b>[Serial Digital Interface]</b> | The standard by which video signals in various SD and HD formats are transmitted along a single coaxial cable.   |
| <b>Self Key</b>                                 | A function that creates key signals from key fill signals for combining keys.  |
| <b>Tally</b>                                    | The signal which outputs the program output statuses of the input signals to an external device. The LED that indicates the program output status on the control panel is also referred to as tally. |
| <b>Transition</b>                               | A function that switches from one image to another.<br>Wipe, mix and other effects are available for the images during switching.  |
| <b>Tri-level Sync</b>                           | The sync signal used for HD formats.   |
| <b>Wipe</b>                                     | A video effect in which one image is gradually replaced by another as the boundary between the two is moved using a preselected pattern.   |







# Panasonic<sup>®</sup>

**PANASONIC BROADCAST & TELEVISION SYSTEMS COMPANY**  
UNIT COMPANY OF PANASONIC CORPORATION OF NORTH AMERICA

**Headquarters:**

3 Panasonic Way 4E-7, Secaucus, NJ 07094 (201) 348-5300

**EASTERN ZONE:**

3 Panasonic Way 4E-7, Secaucus, NJ 07094 (201) 348-7196

**WESTERN ZONE:**

3330 Cahuenga Blvd. West, Los Angeles, CA 90068 (323) 438-3608

**Government office:**

(201) 348-7587

**Broadcast PARTS INFORMATION & ORDERING:**

9:00 a.m. – 5:00 p.m. (PST) (800) 334-4881/24 Hr. Fax (800) 334-4880

Emergency after hour parts orders (800) 334-4881

**TECHNICAL SUPPORT:**

Emergency 24 Hour Service (800) 222-0741

**Panasonic Canada Inc.**

5770 Ambler Drive, Mississauga, Ontario L4W 2T3 (905) 624-5010

**Panasonic de Mexico S.A. de C.V.**

Av angel Urraza Num. 1209 Col. de Valle 03100 Mexico, D.F. (52) 1 951 2127

**Panasonic Puerto Rico Inc.**

San Gabriel Industrial Park, 65th Infantry Ave., Km. 9.5, Carolina, Puerto Rico 00630 (787) 750-4300

© 2006 Matsushita Electric Industrial Co., Ltd. All rights reserved.

---

**Matsushita Electric Industrial Co., Ltd.**

Web Site: <http://panasonic.net>